

CREA

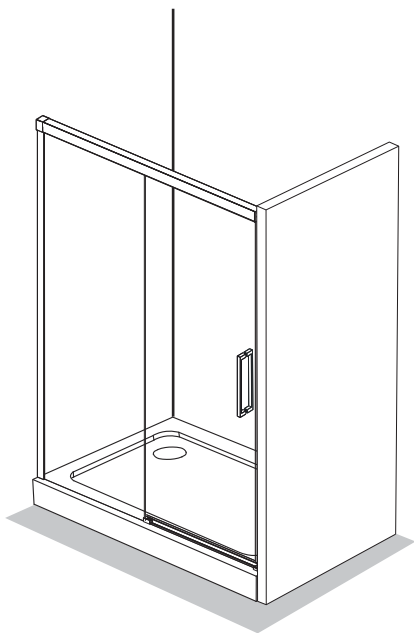

PL INSTRUKCJA MONTAŻU I EKSPLOATACJI

CZ NÁVOD NA MONTÁŽ A ÚDRŽBU

SK NÁVOD NA MONTÁŽ A ÚDRŽBU

EST PAIGALDUS- JA KASUTUSJUHEND

LT MONTAVIMO IR EKSPLOAVIMO INSTRUKCIJA

LV MONTĀŽAS UN EKSPLUATĀCIJAS INSTRUKCIJA

DE MONTAGE- UND AUFBAUANLEITUNG

RO INSTRUCȚIUNI DE MONTAJ ȘI OPERARE

HU SZERELÉSI ÉS ÜZEMELTETÉSI ÚTMUTATÓ

UA ІНСТРУКЦІЯ З МОНТАЖУ І ЕКСПЛУАТАЦІЇ

BY ІНСТРУКЦЫЯ ПА МАНТАЖЫ І ЭКСПЛУАТАЦЫІ

RU ИНСТРУКЦИЯ ПО МОНТАЖУ И ЭКСПЛУАТАЦИИ

EN INSTRUCTIONS FOR ASSEMBLY AND USE

FR INSTALLATION ET UTILISATION - MODE

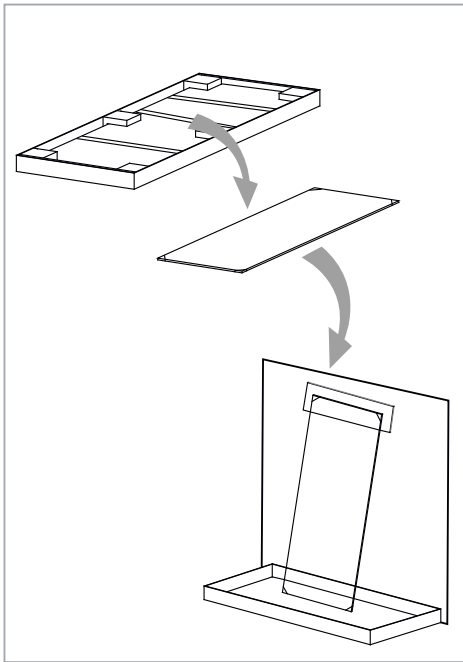
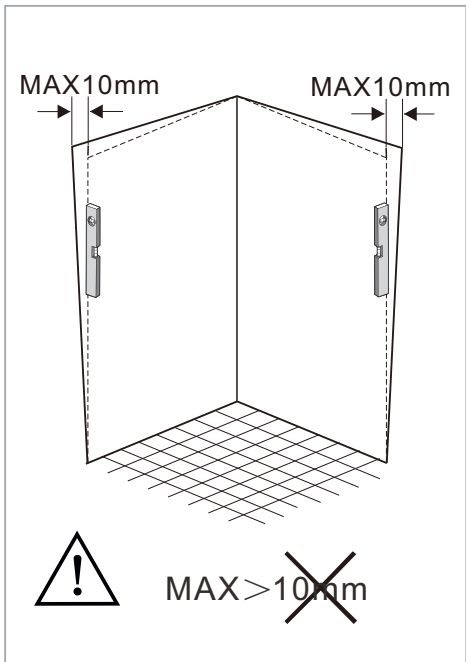
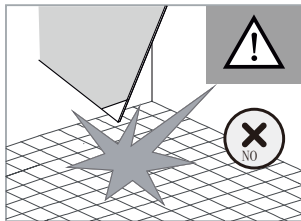
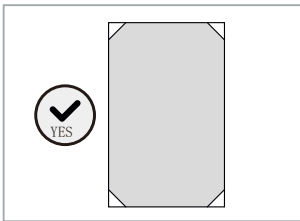
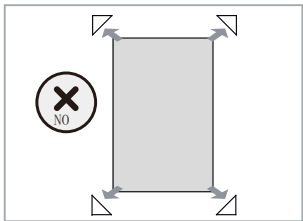
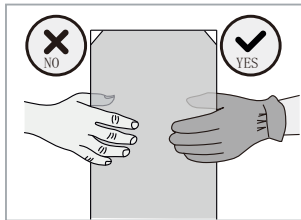
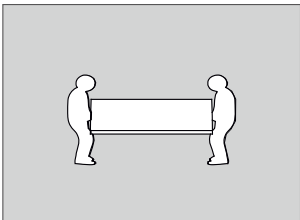
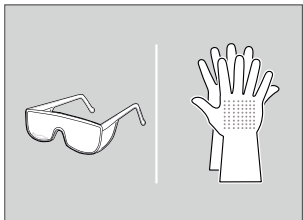
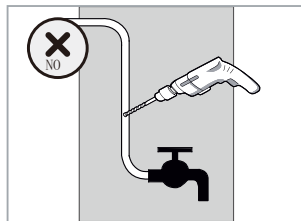
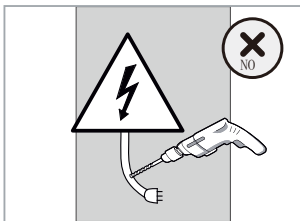
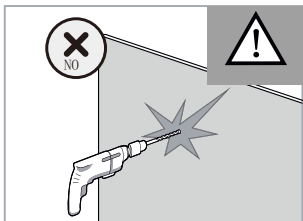

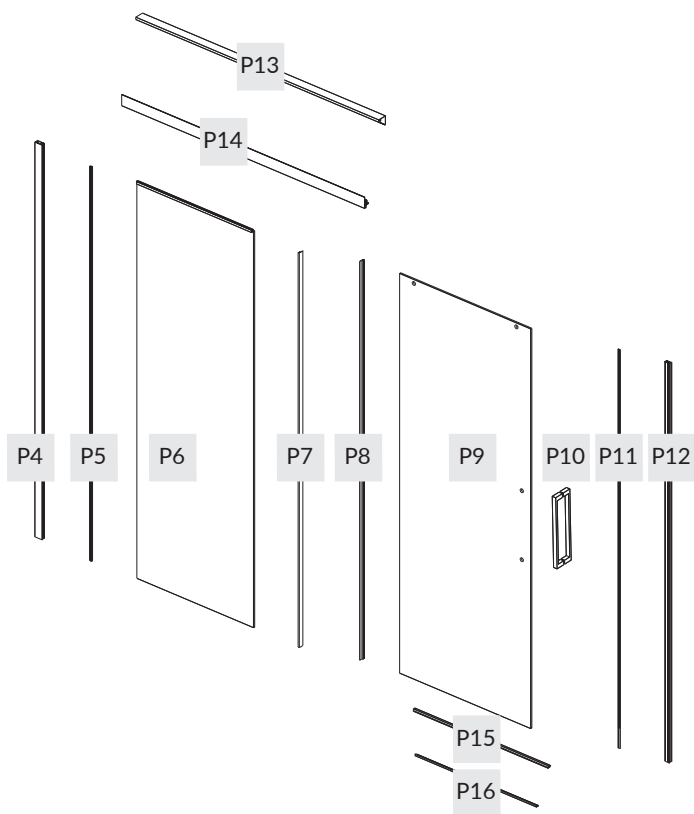

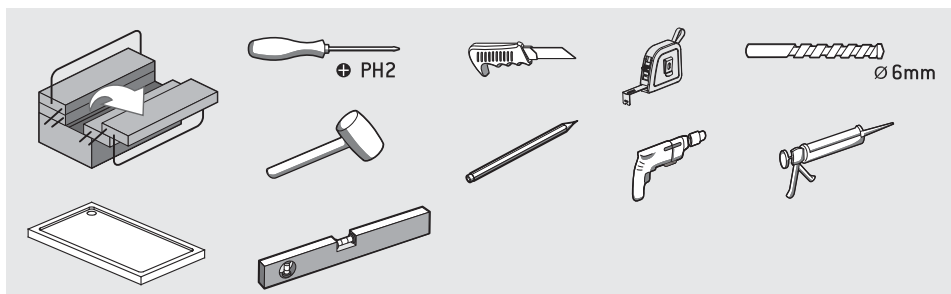
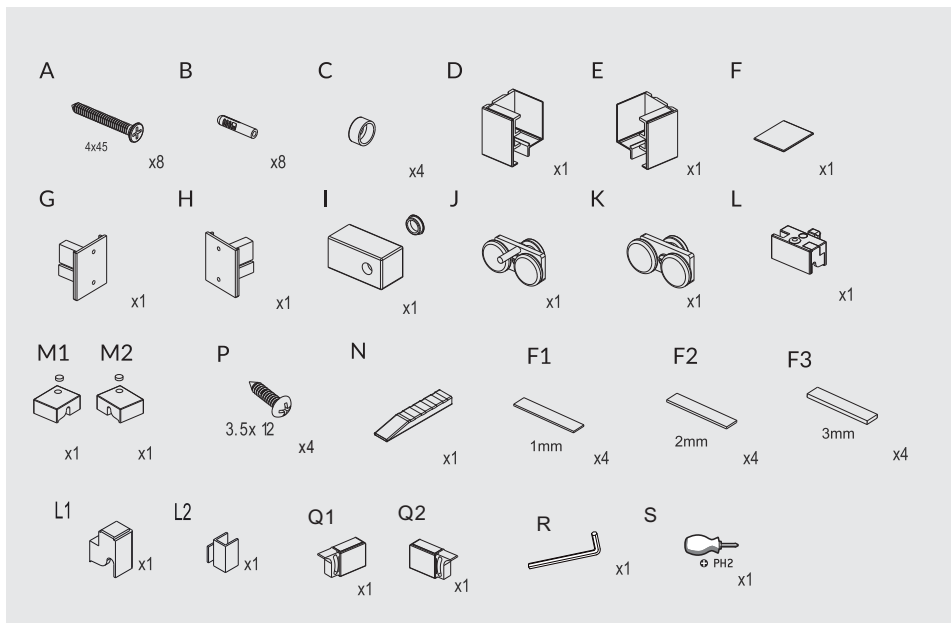

1.

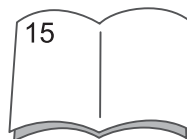
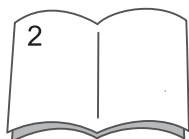
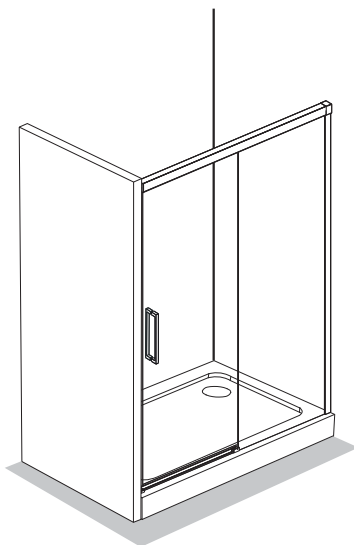
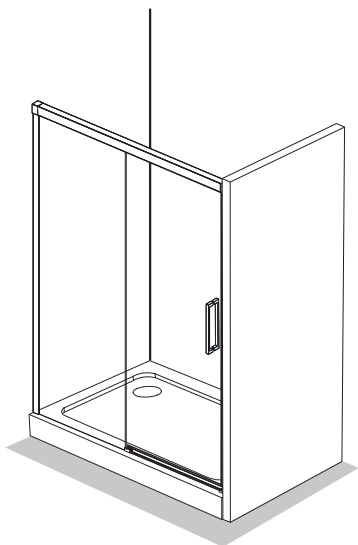

2.

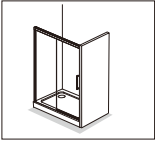

| SIZE | X(mm) |
|-----------|-----------|
| 1200X2000 | 1180-1200 |
| 1400X2000 | 1380-1400 |

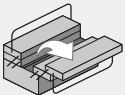
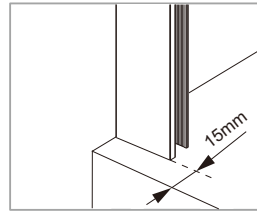
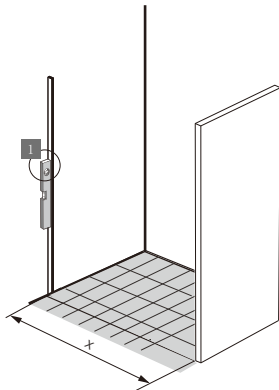
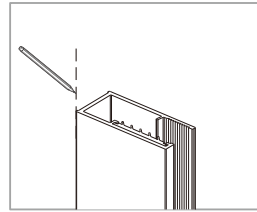
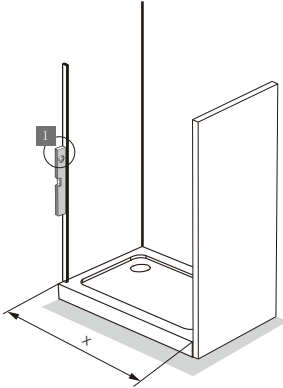

P4



x1



3.

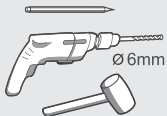
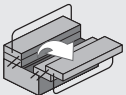
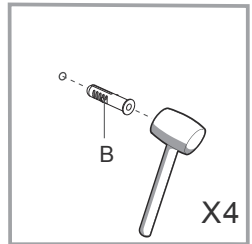
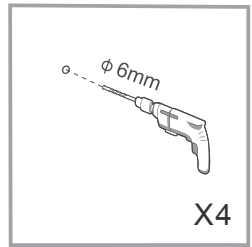
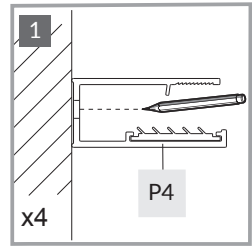
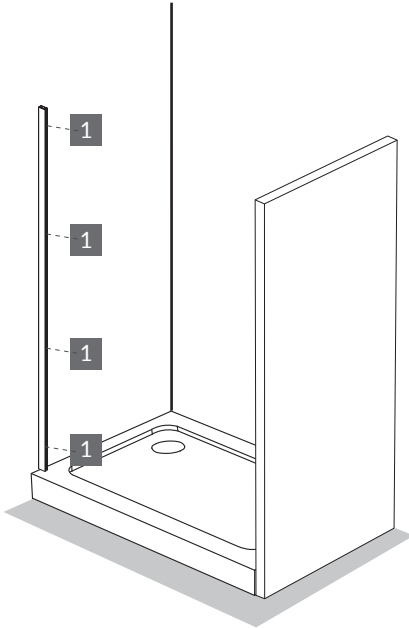
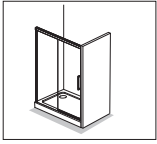

B



x4



4.

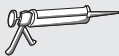
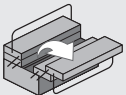
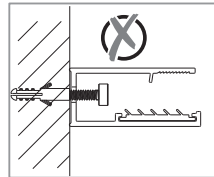
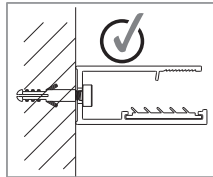
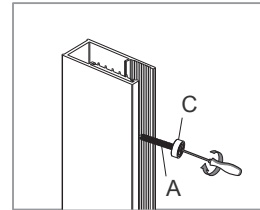
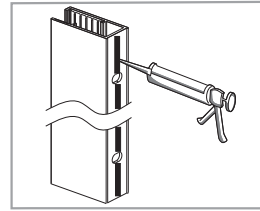
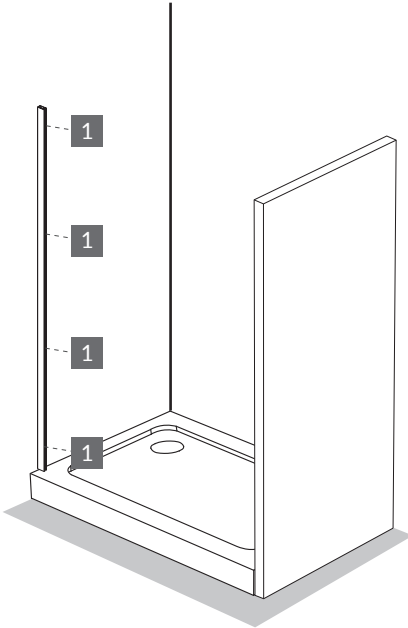
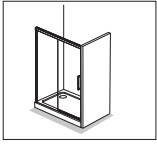

P4



x1

C



x4

A



x4

4X45



5.

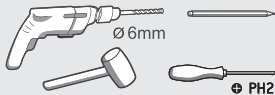
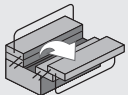
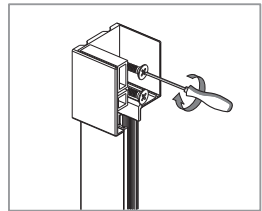
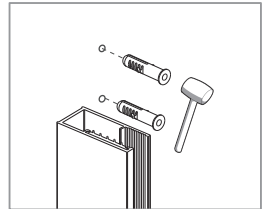
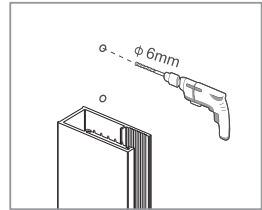
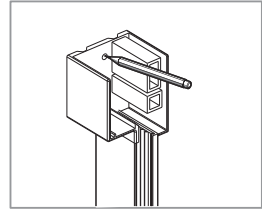
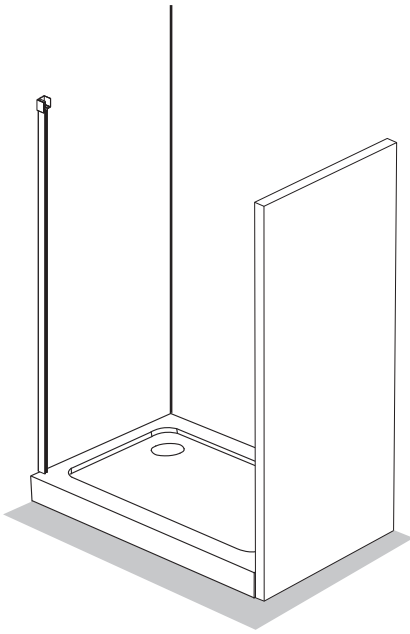
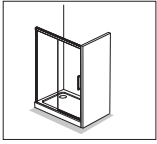

D
B
A



x1



x2



x2



6.

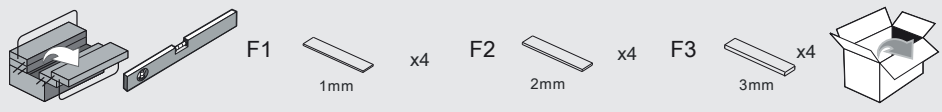
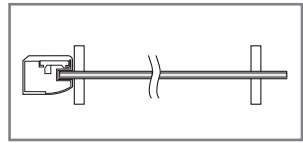
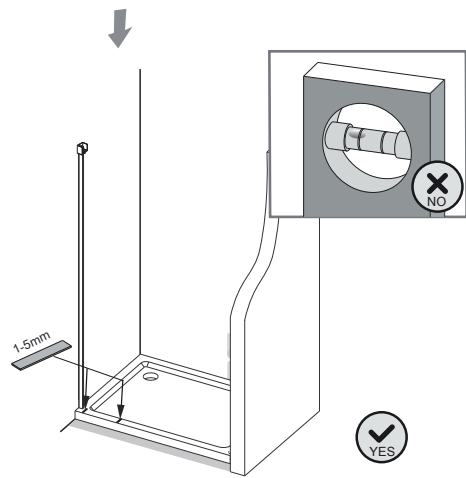
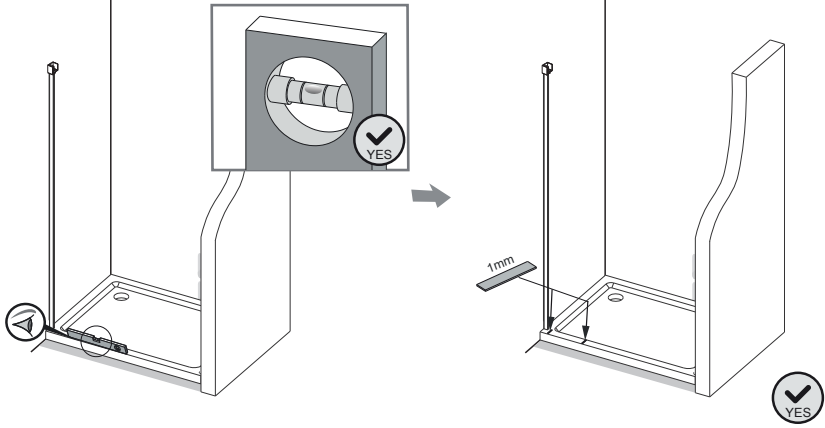
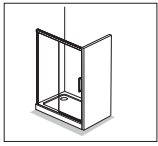

7.

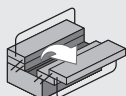
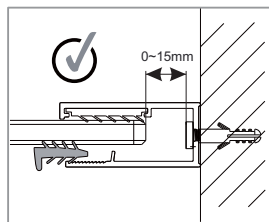
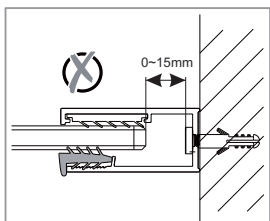
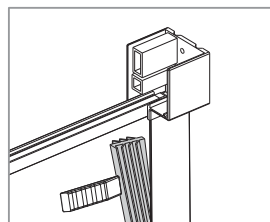
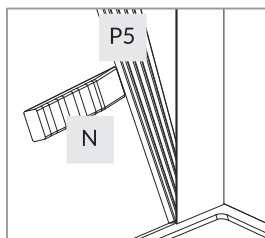
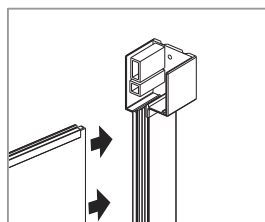
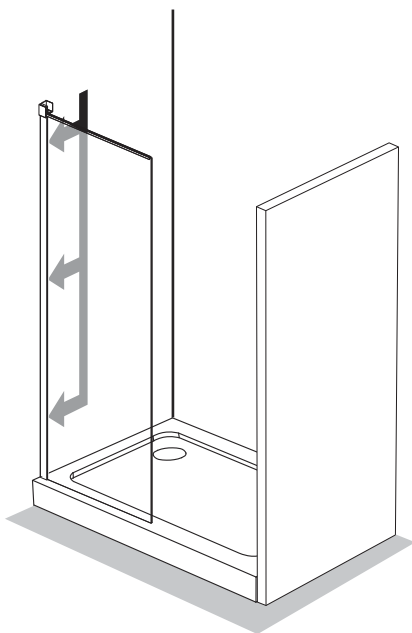
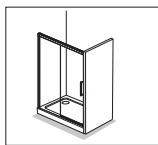

P5 ————— x1

N  x1



8.

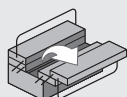
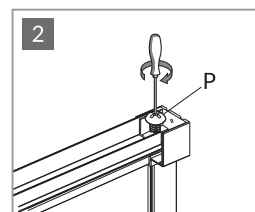
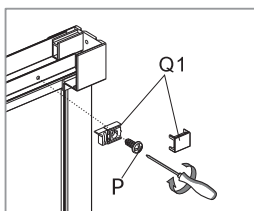
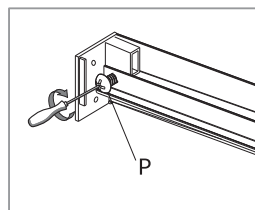
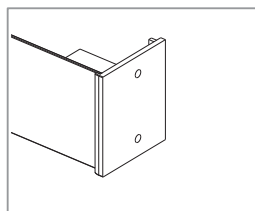
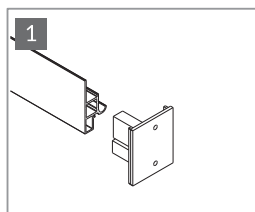
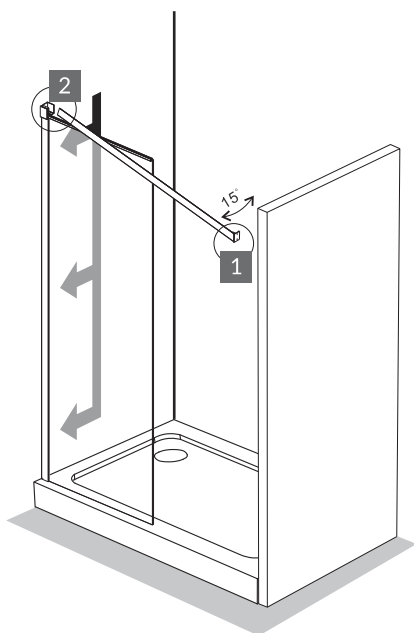
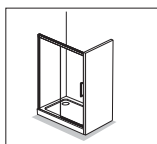

G  x1

S  x1

Q1  x1

P  x3



9.

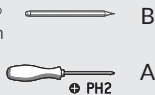
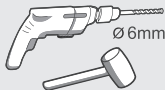
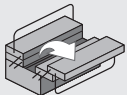
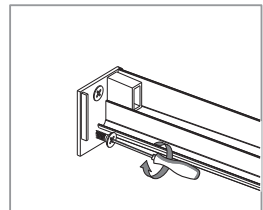
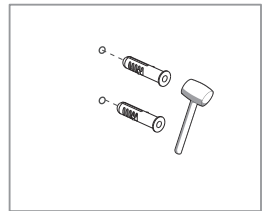
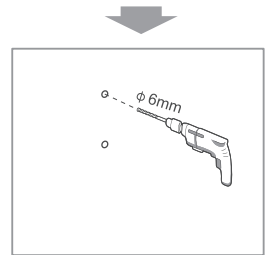
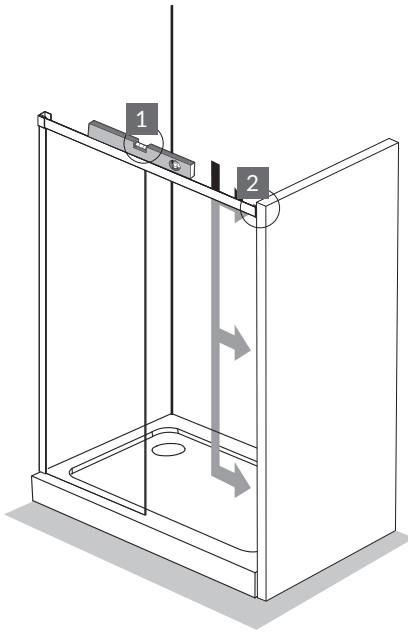
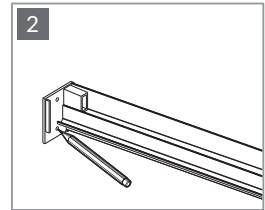
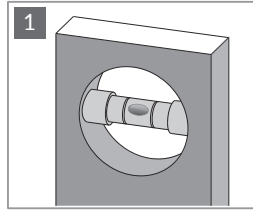
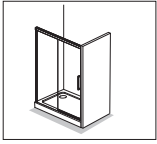

x2



x2



10.

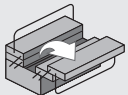
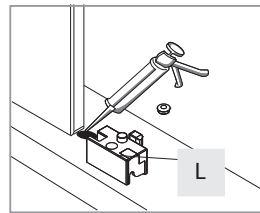
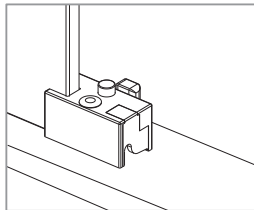
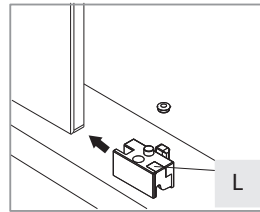
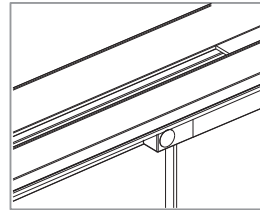
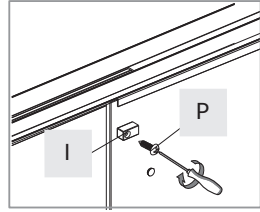
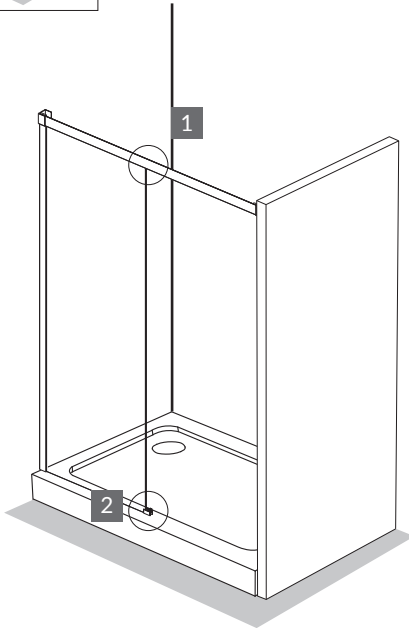
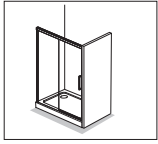

L



x1

I



x1

P



3.5x12 x1



12.

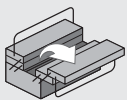
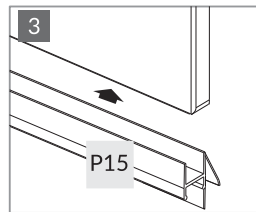
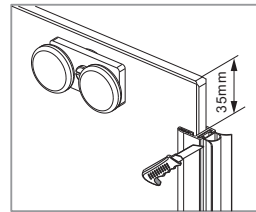
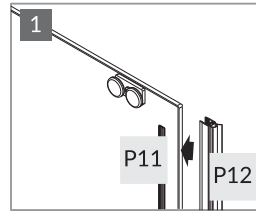
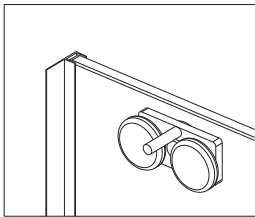
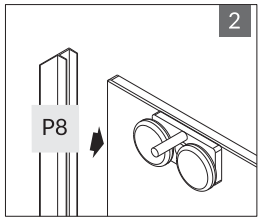
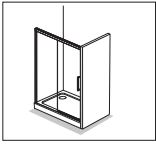

- P12  x1
- P11  x1
- P8  x1
- P15  x1



13.

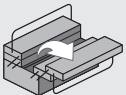
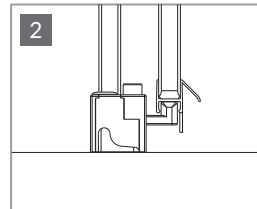
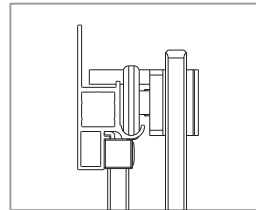
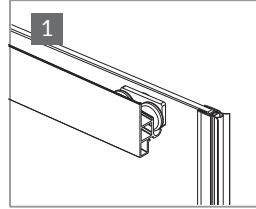
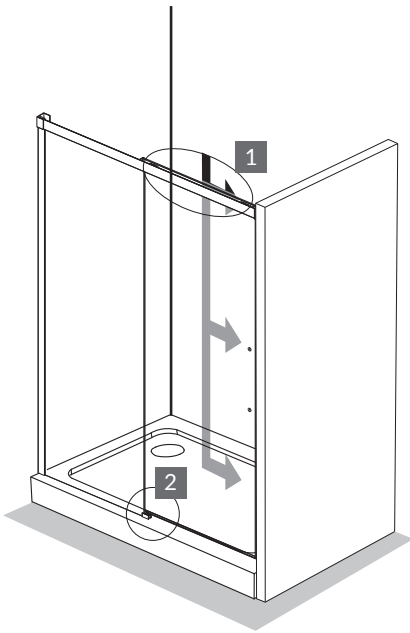
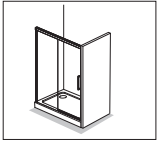

14.

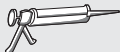
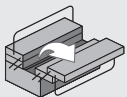
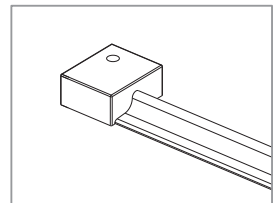
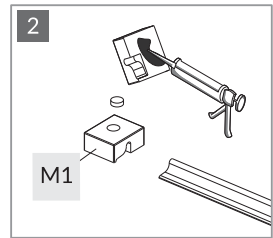
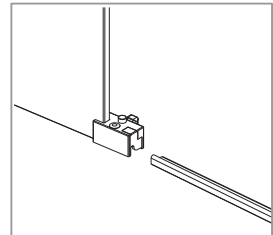
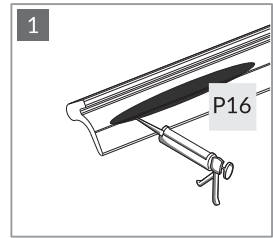
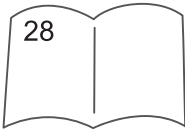
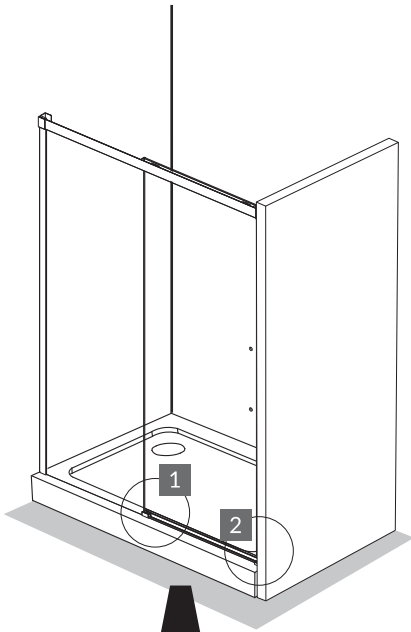
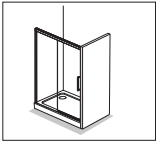

P16 ————— x1

M1  x1



15.

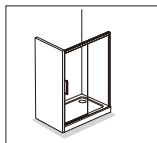

| SIZE | X(mm) |
|-----------|-----------|
| 1200X2000 | 1180-1200 |
| 1400X2000 | 1380-1400 |

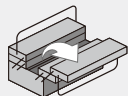
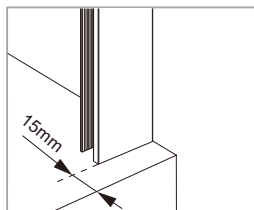
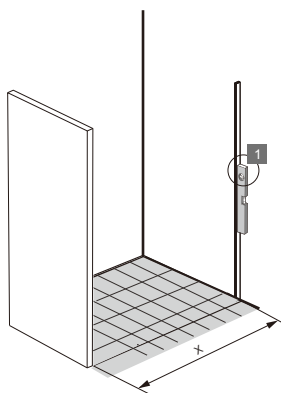
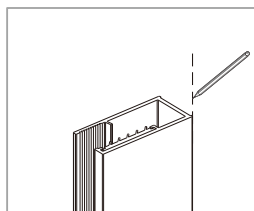
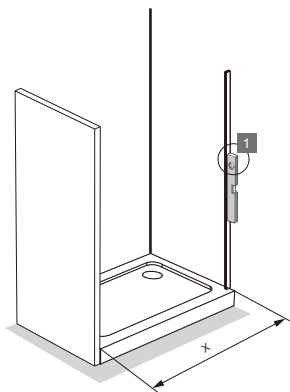

P4  x1



16.

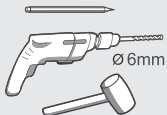
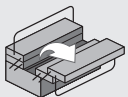
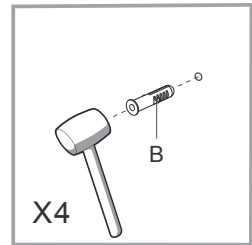
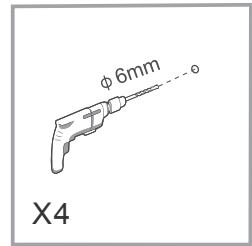
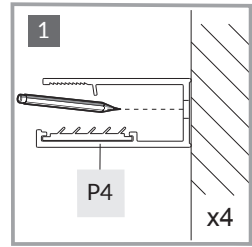
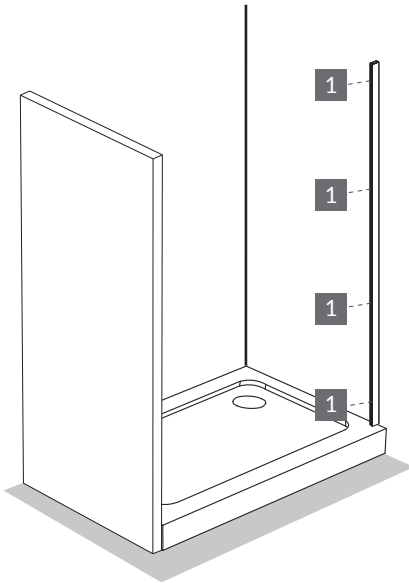
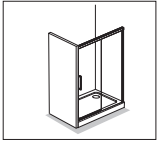

B



x4



17.

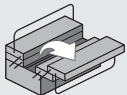
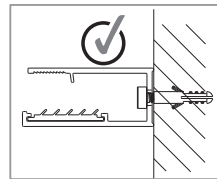
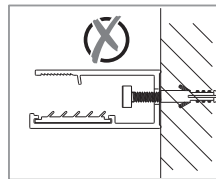
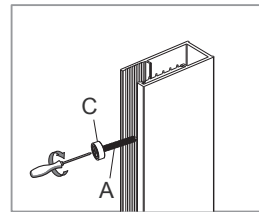
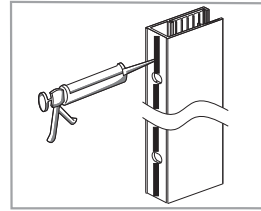
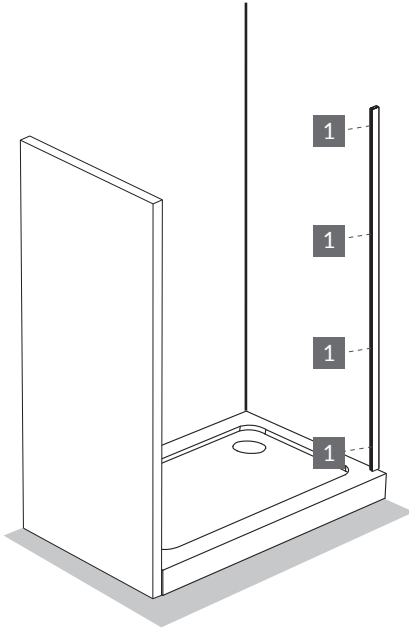
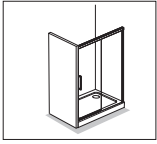

P4



x1

C



x4

A



x4

4X45



18.

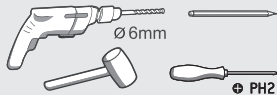
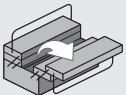
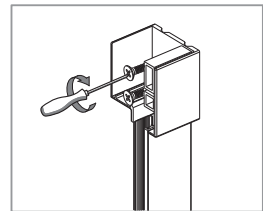
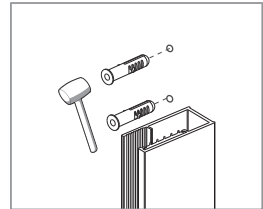
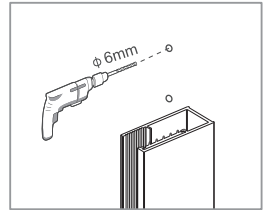
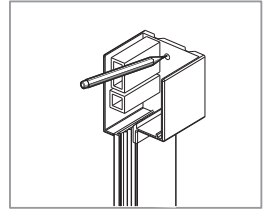
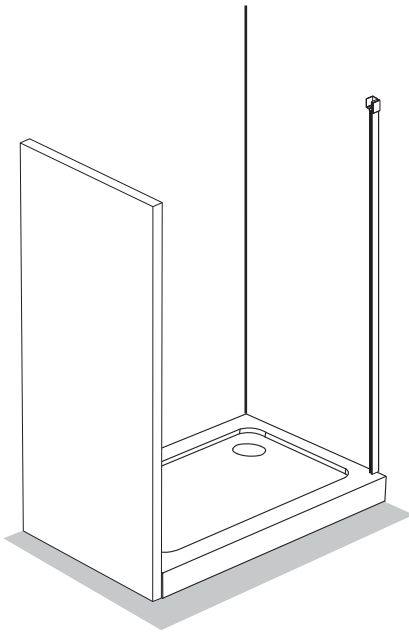
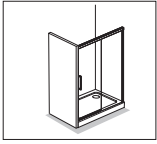

E
B
A



x1
x2
x2



19.

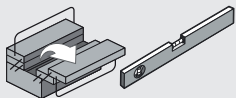
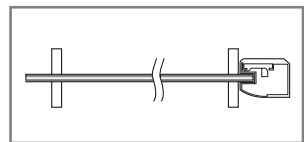
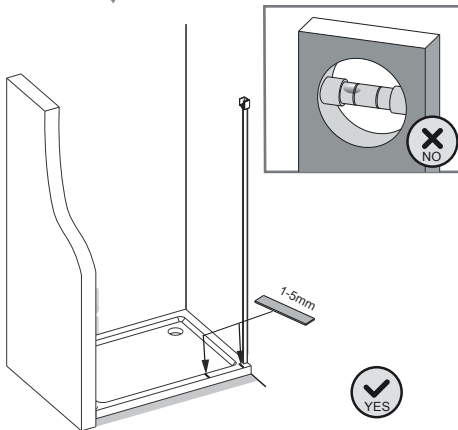
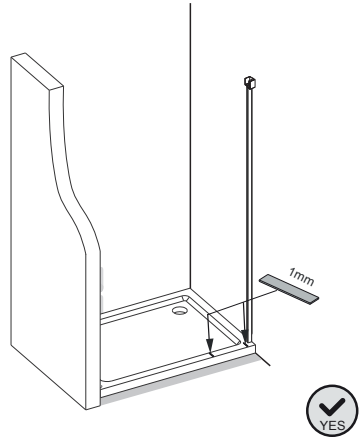
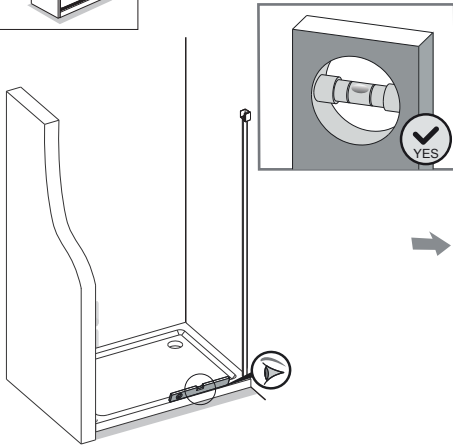
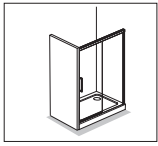

F1



x4

F2



x4

F3



x4



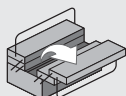
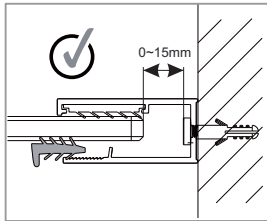
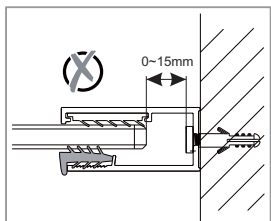
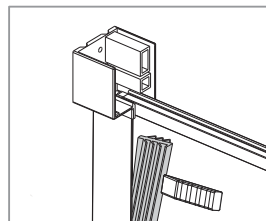
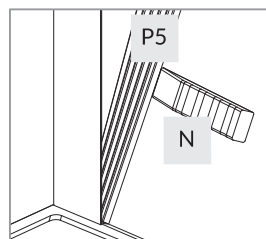
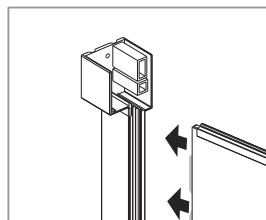
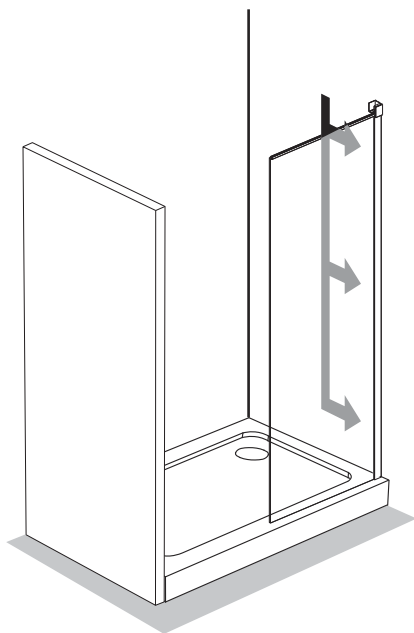
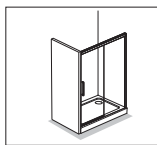



P5 ————— x1

N x1

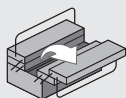
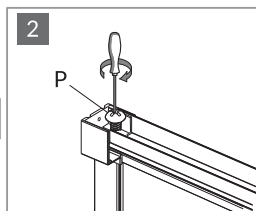
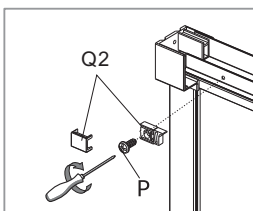
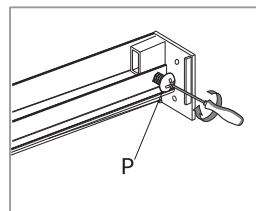
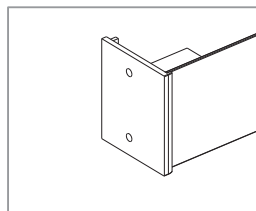
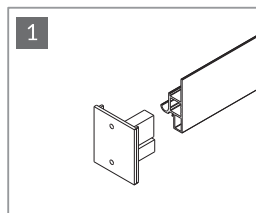
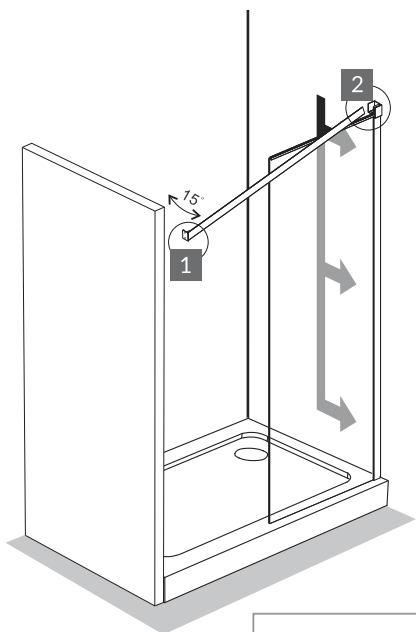
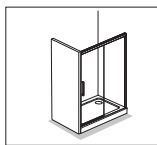



H  x1

S  x1
Ø PH2

Q2  x1

P  x3
3.5x 12



22.

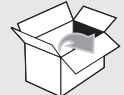
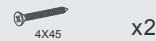
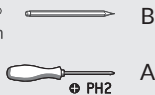
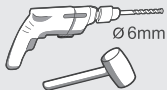
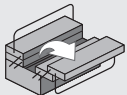
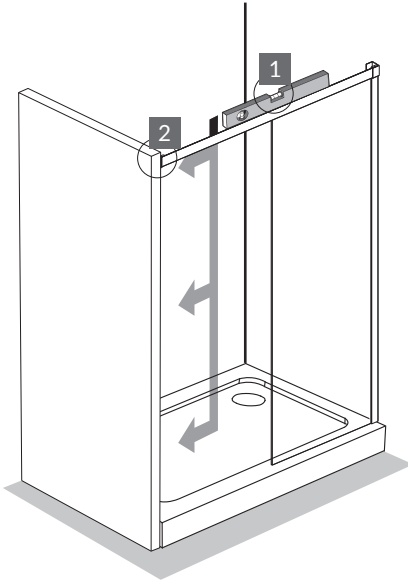
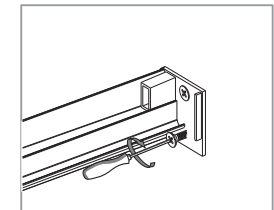
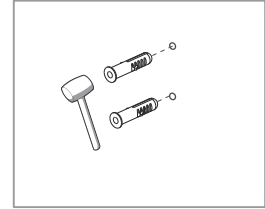
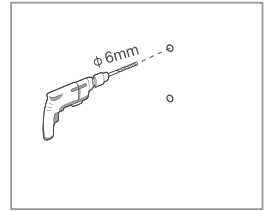
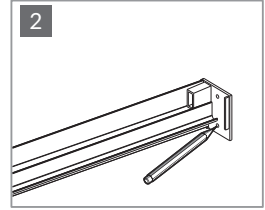
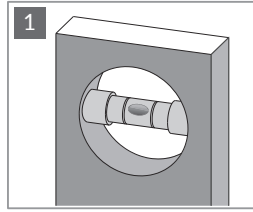
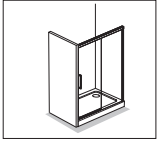

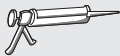
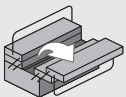
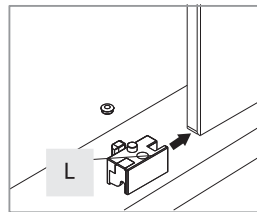
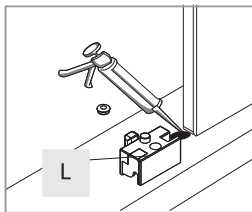
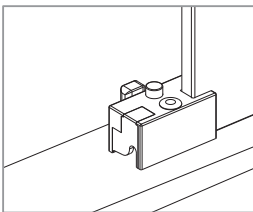
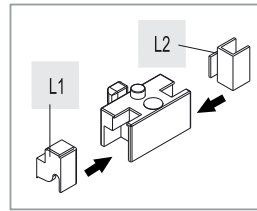
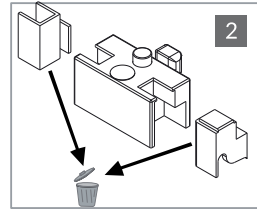
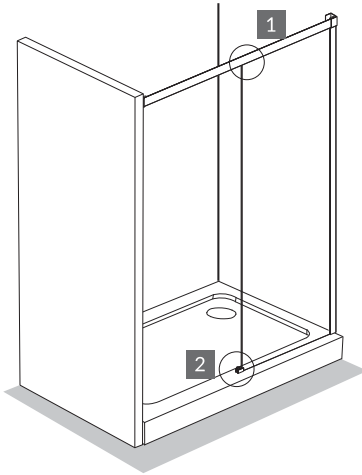
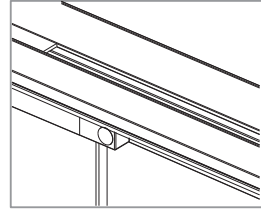
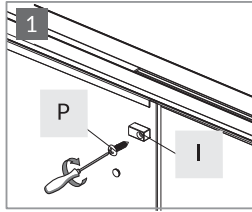
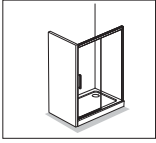

x1



x1



x1



x1

I



P



x1

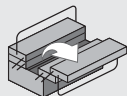
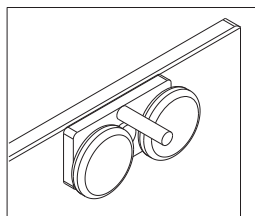
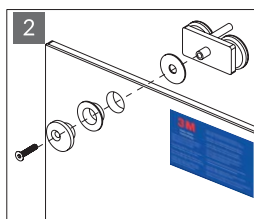
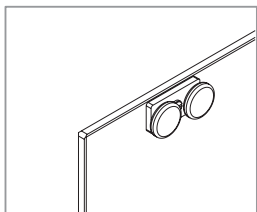
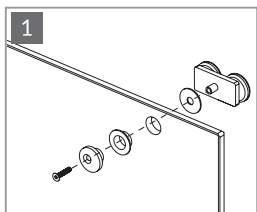
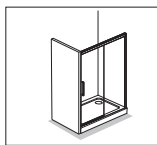



- R  x1
- J  x1
- K  x1



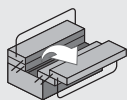
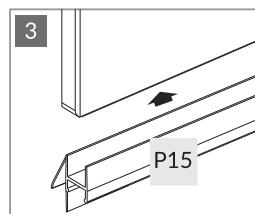
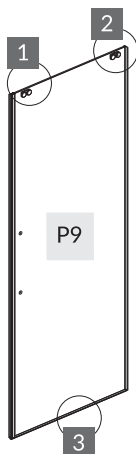
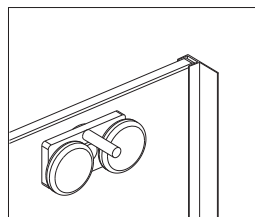
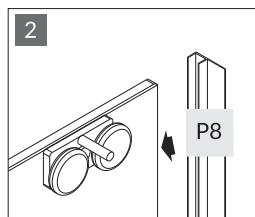
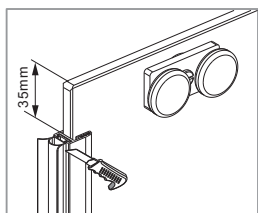
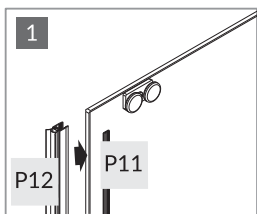
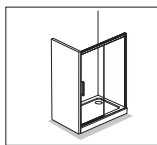

- P12  x1
- P11  x1
- P8  x1
- P15  x1



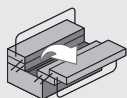
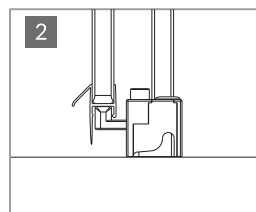
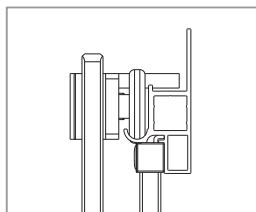
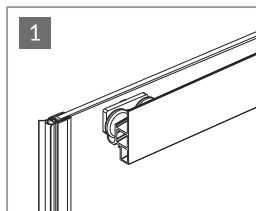
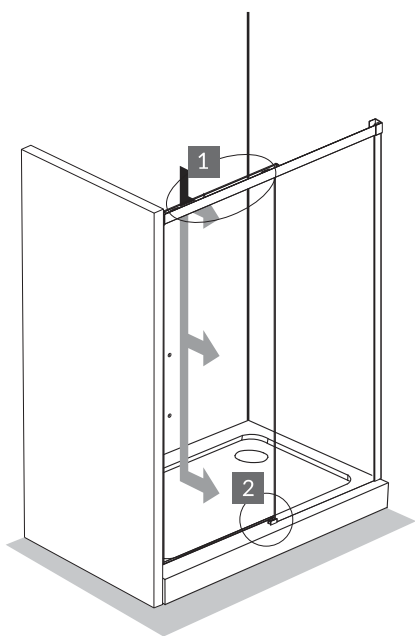
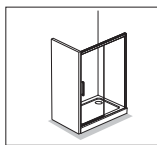

27.

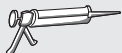
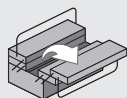
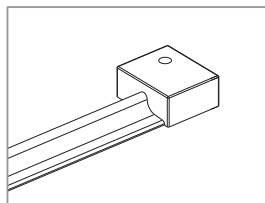
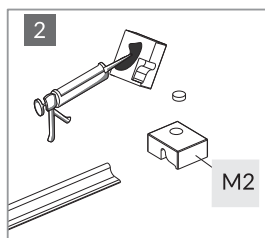
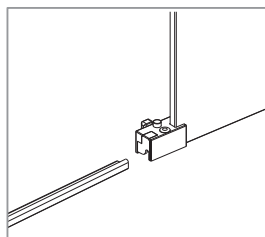
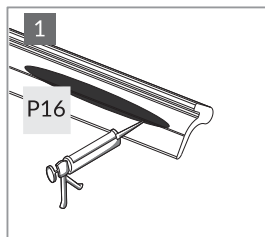
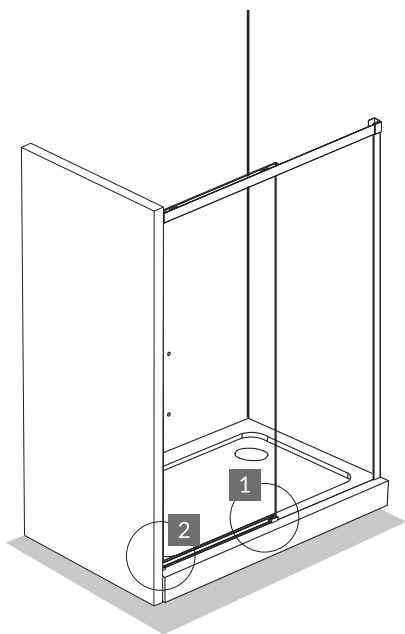
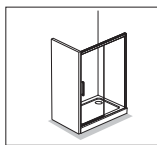

P16

x1

M2



x1



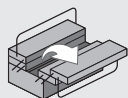
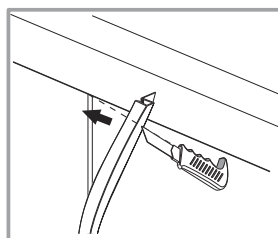
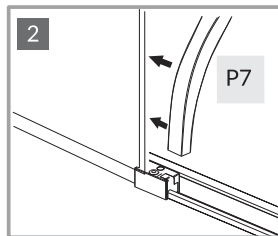
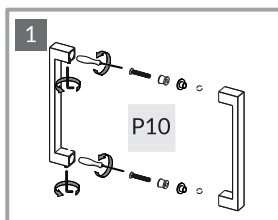
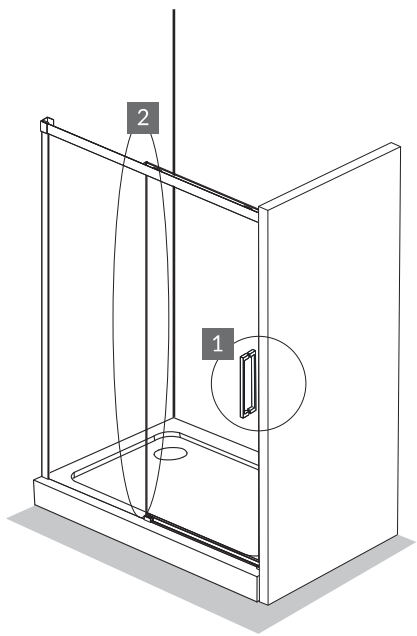

P7



x1

P10

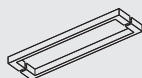

x1



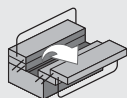
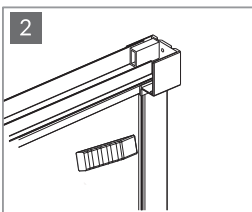
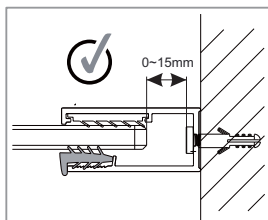
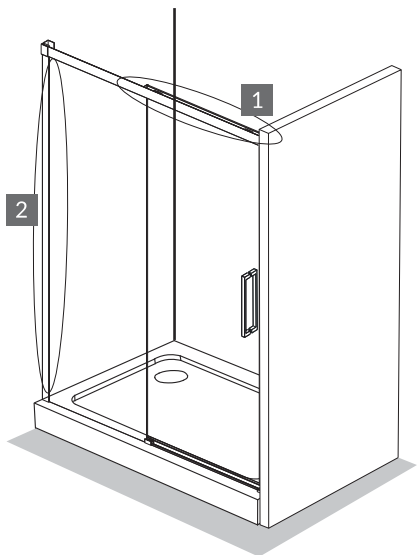
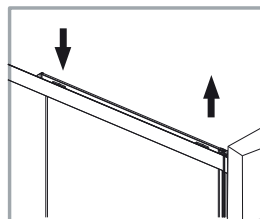
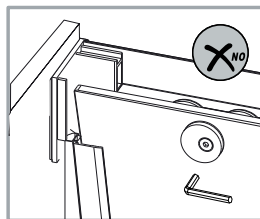
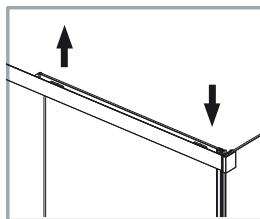
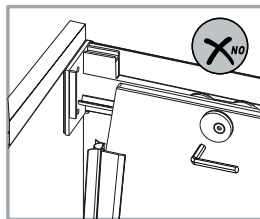
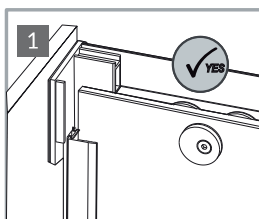

R



x1

N



x1



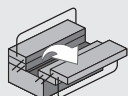
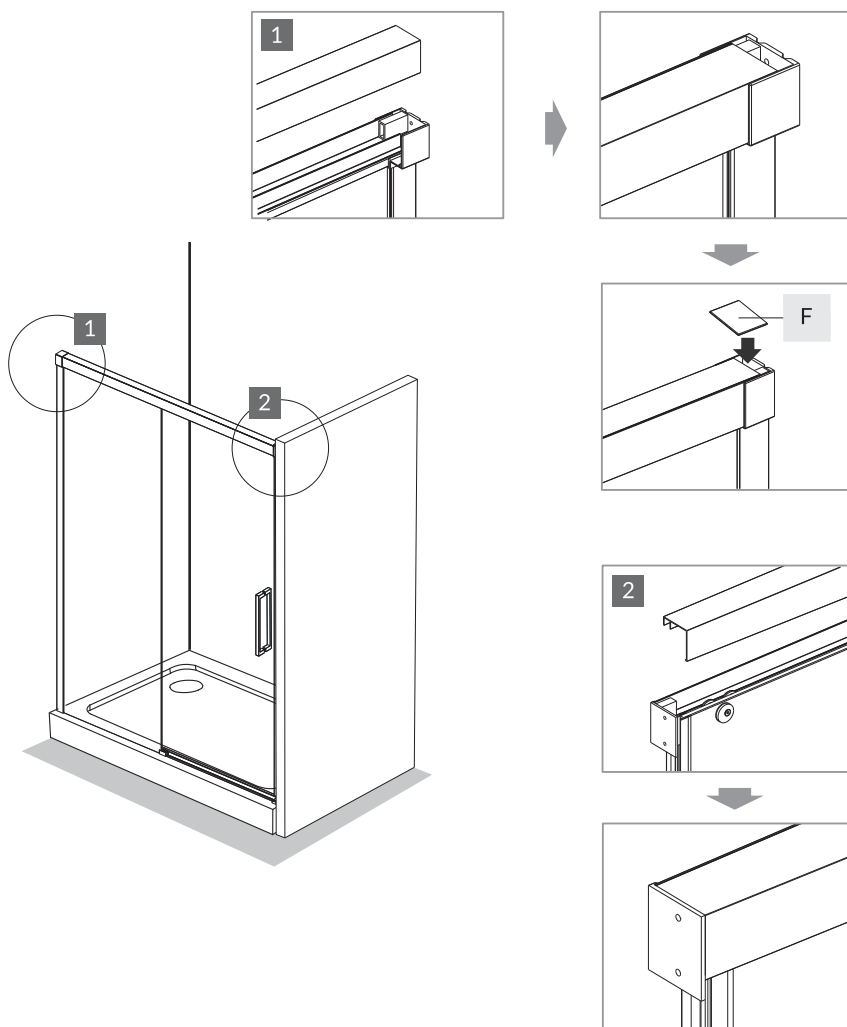

P13



F x1



31.

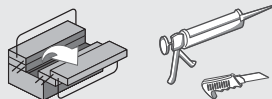
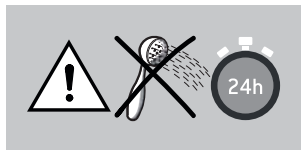
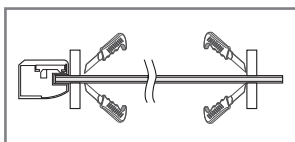
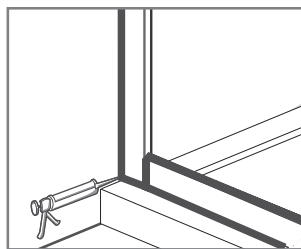
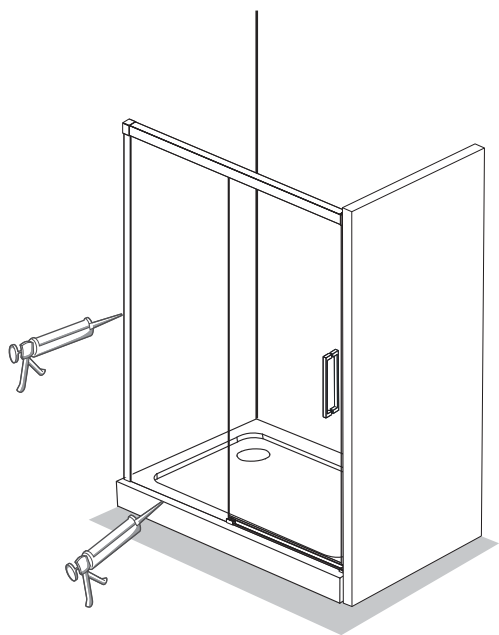



6.5 < PH < 7.5

