

Moduo

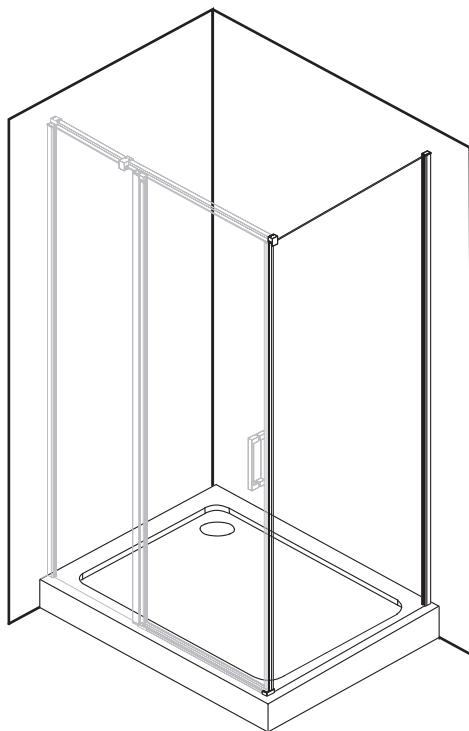

PL INSTRUKCJA MONTAŻU I EKSPLOATACJI

CZ NÁVOD NA MONTÁŽ A ÚDRŽBU

SK NÁVOD NA MONTÁŽ A ÚDRŽBU

EST PAIGALDUS- JA KASUTUSJUHEND

LT MONTAVIMO IR EKSPLOATAVIMO INSTRUKCIJA

LV MONTĀŽAS UN EKSPLUATĀCIJAS INSTRUKCIJA

DE MONTAGE- UND AUFBAUANLEITUNG

RO INSTRUCȚIUNI DE MONTAJ ȘI OPERARE

HU SZERELÉSI ÉS ÜZEMELTETÉSI ÚTMUTATÓ

UA ІНСТРУКЦІЯ З МОНТАЖУ І ЕКСПЛУАТАЦІЇ

BY ІНСТРУКЦЫЯ ПА МАНТАЖЫ І ЭКСПЛУАТАЦЫІ

RU ИНСТРУКЦИЯ ПО МОНТАЖУ И ЭКСПЛУАТАЦИИ



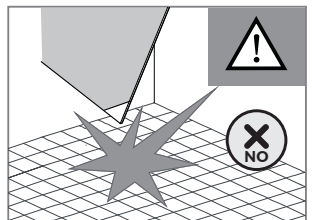
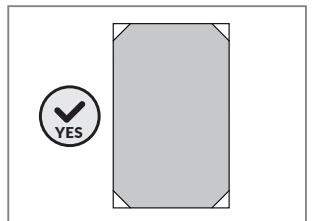
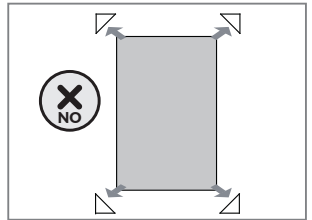
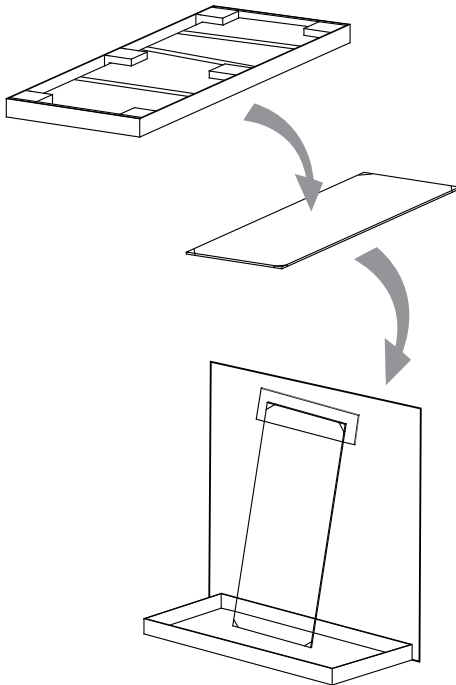
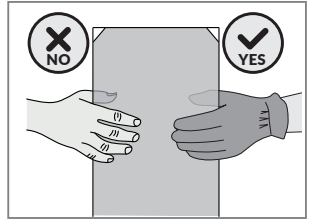
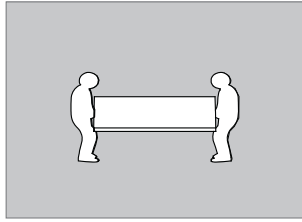
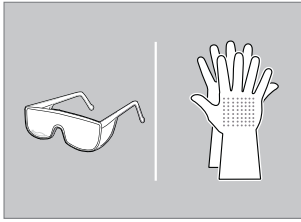
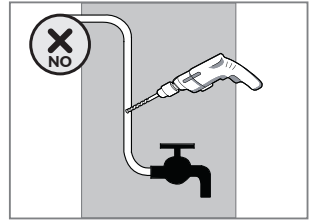
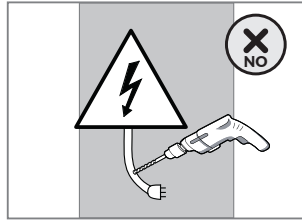
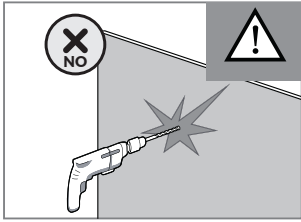

EN INSTRUCTIONS FOR ASSEMBLY AND USE

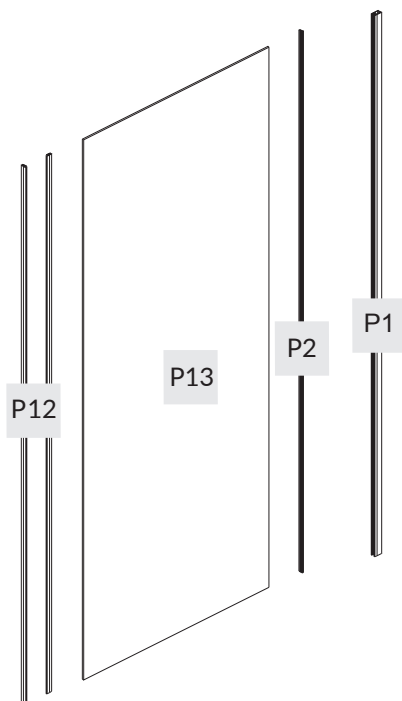
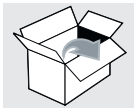

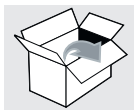

FR INSTALLATION ET UTILISATION - MODE







D  x4 F1  x4 F2  x4 F3  x4

M1  x1 M2  x1 L1  x1 L2  x1

Q  x1

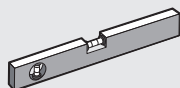
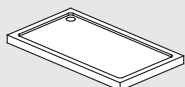
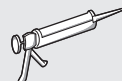
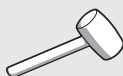
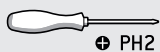
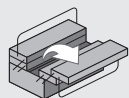

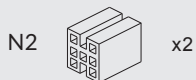
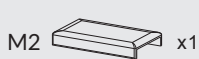
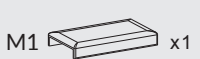
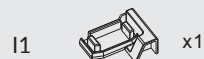
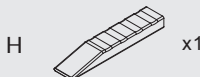
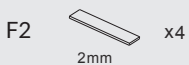
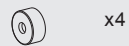
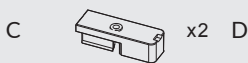
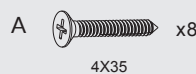
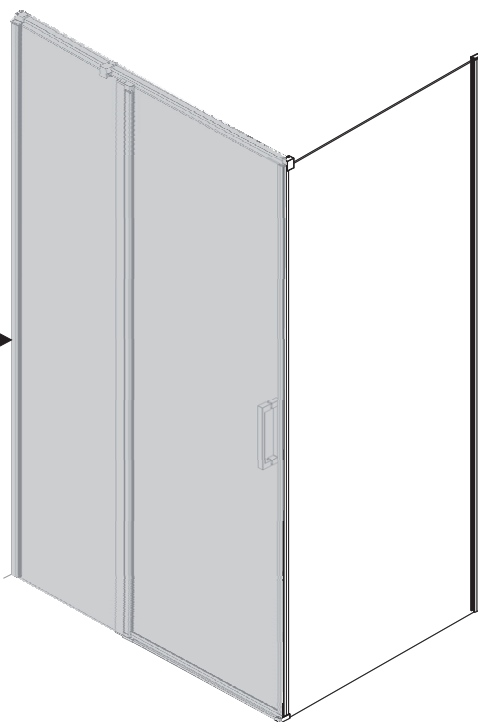
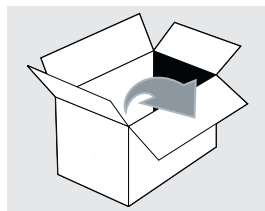

1.

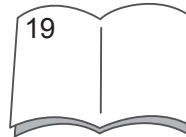
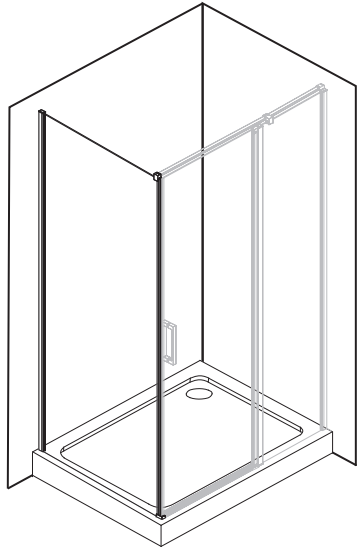
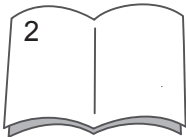
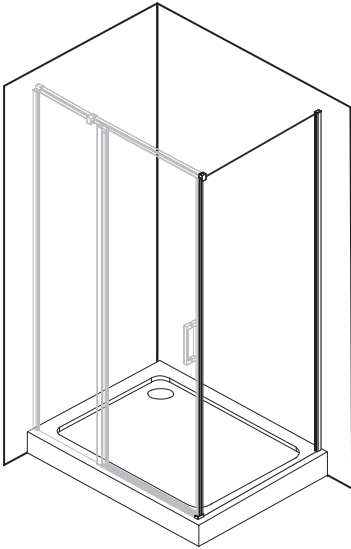

2.

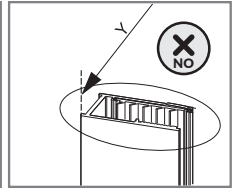
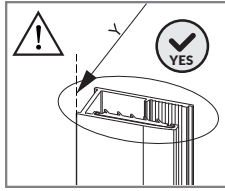
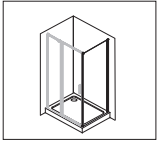

SIZE	X(mm)	Y(mm)
800x800x1950	790-800	790-800
900x800x1950	890-900	790-800
1000x800x1950	990-1000	790-800
800x900x1950	790-800	890-900
900x900x1950	890-900	890-900
1000x900x1950	990-1000	890-900

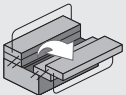
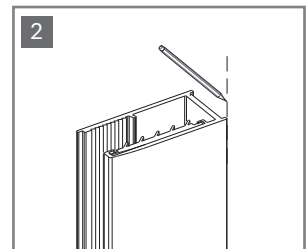
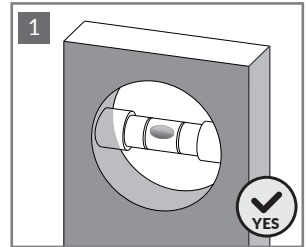
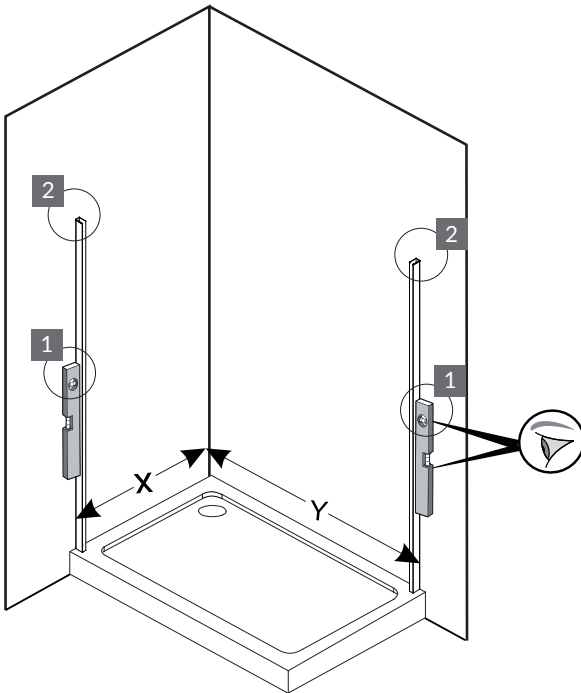

P1



x2



3.

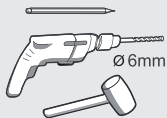
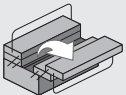
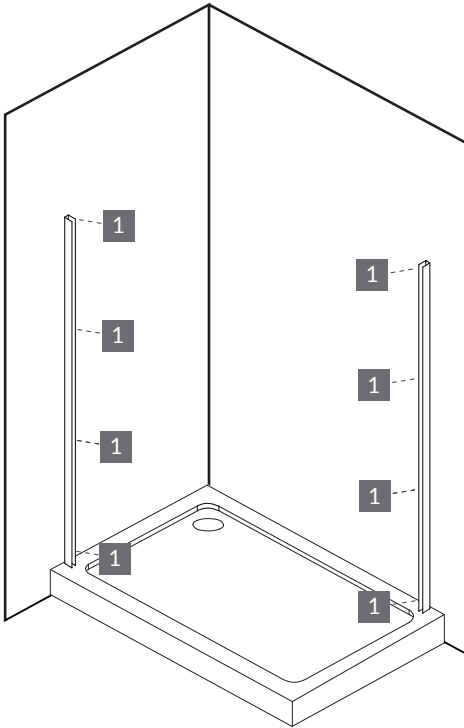
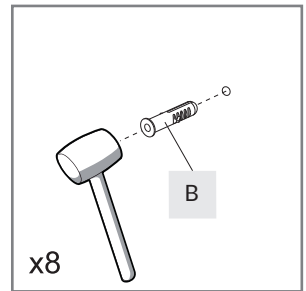
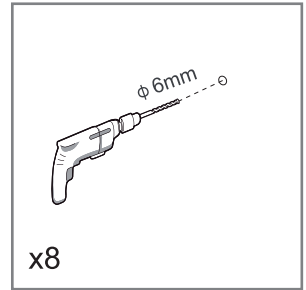
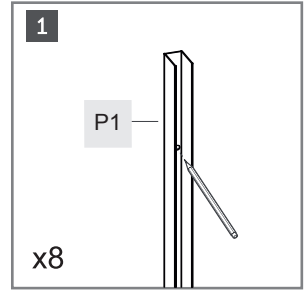
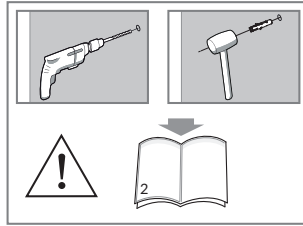
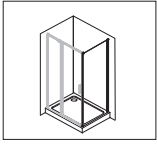

B



x8



4.

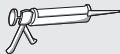
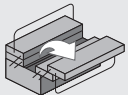
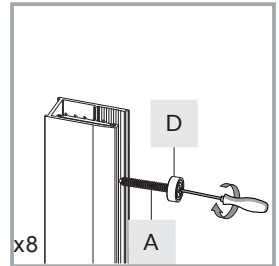
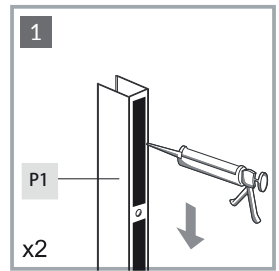
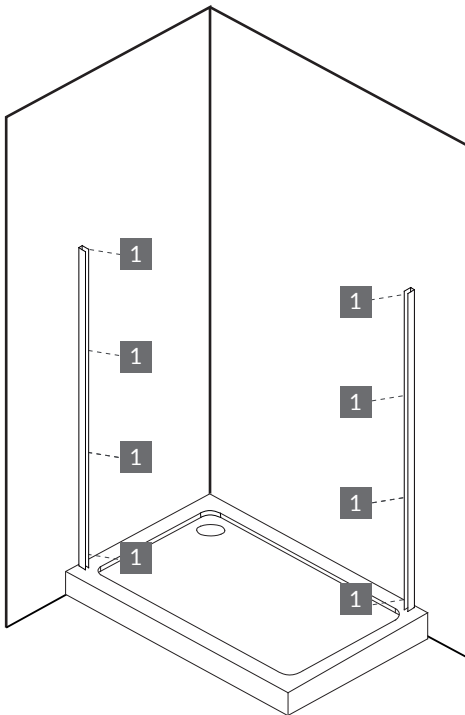
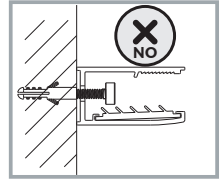
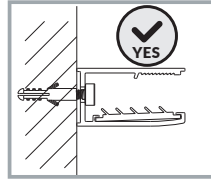
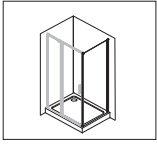

P1



x2

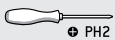

PH2

D



x8

A



x8



5.

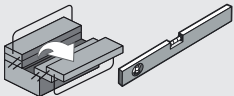
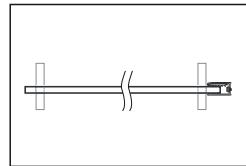
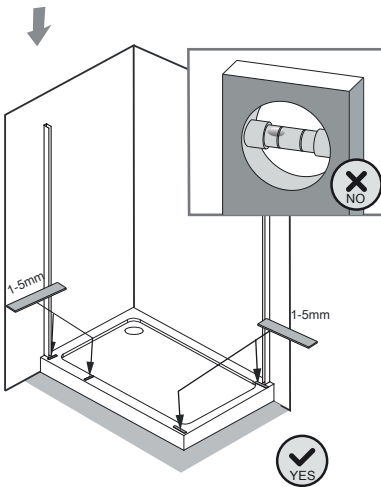
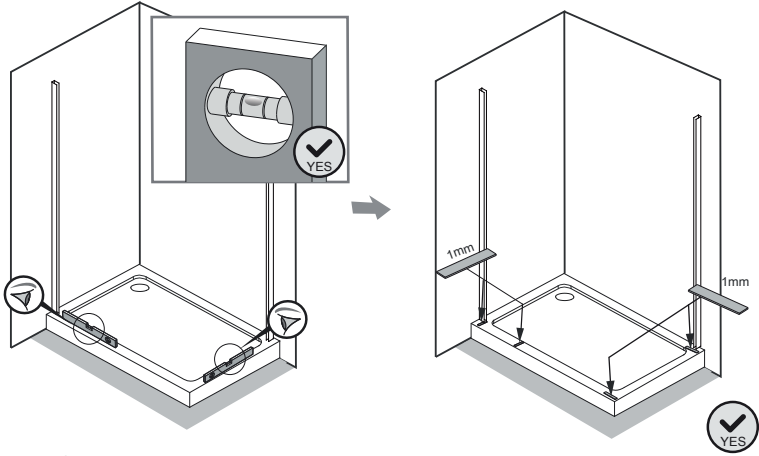
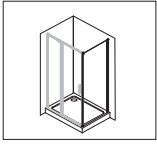

F1



x4

F2



x4

F3



x4



6.

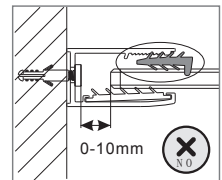
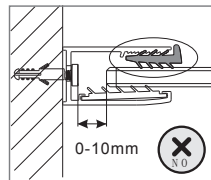
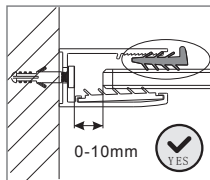
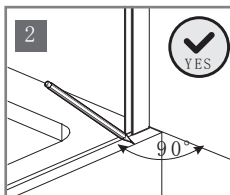
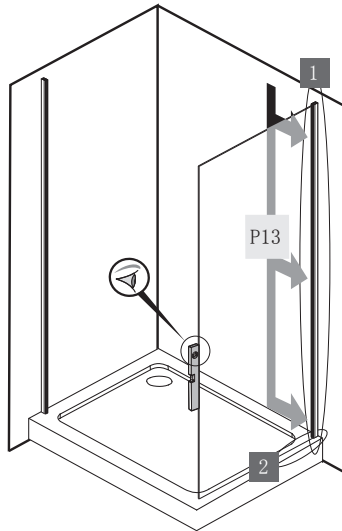
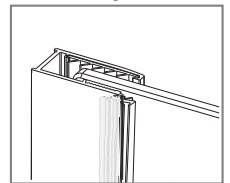
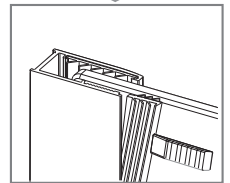
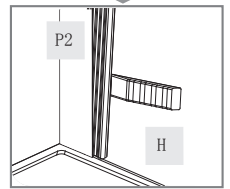
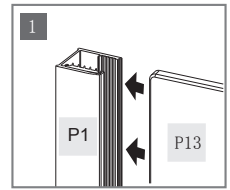
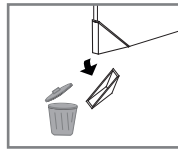
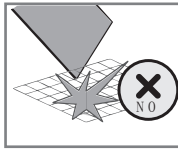
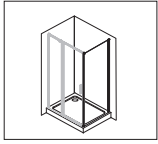

7.

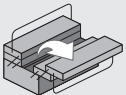
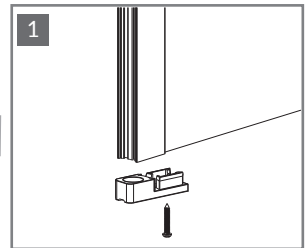
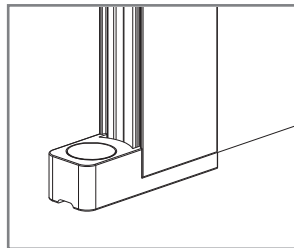
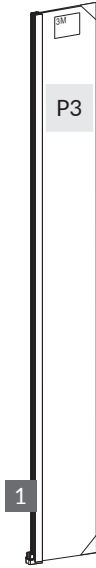
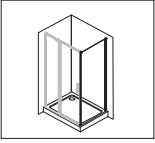

C

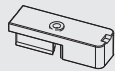

x1

E



x1



8.

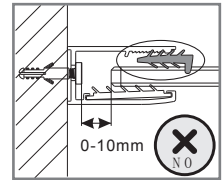
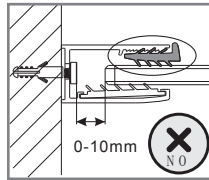
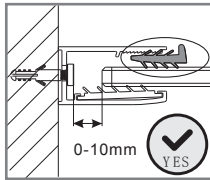
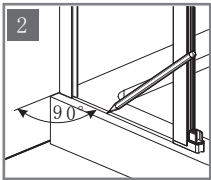
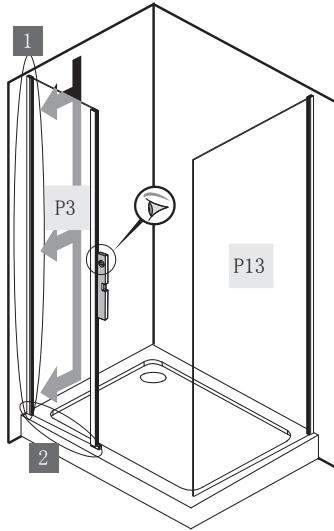
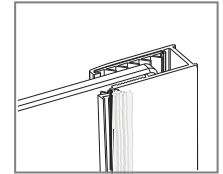
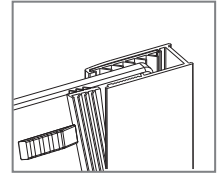
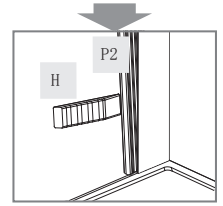
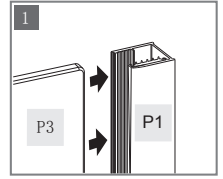
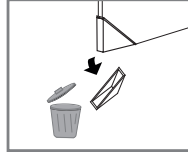
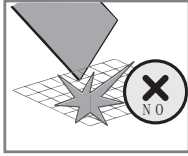
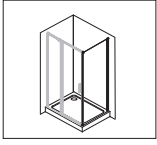

9.

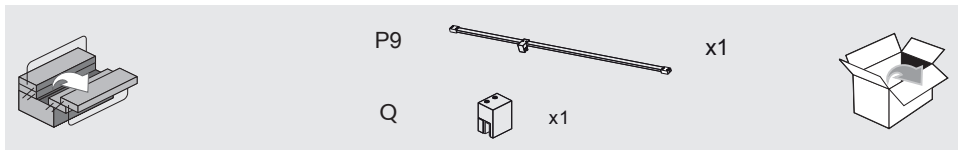
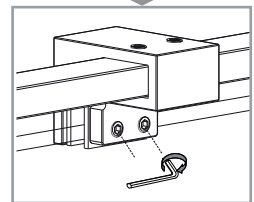
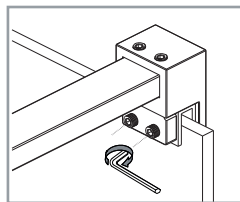
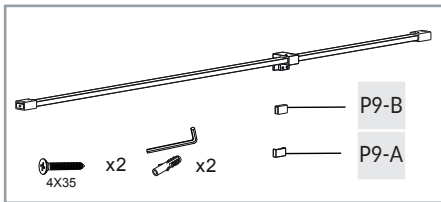
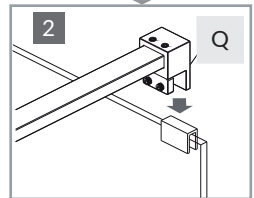
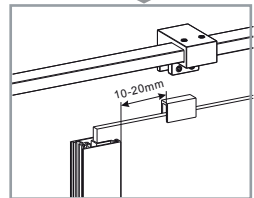
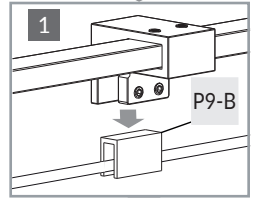
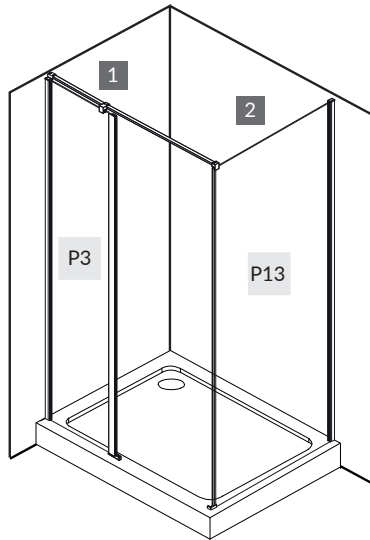
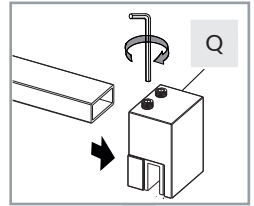
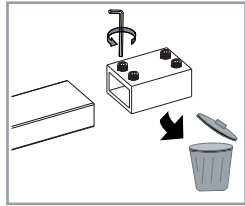
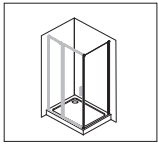

10.

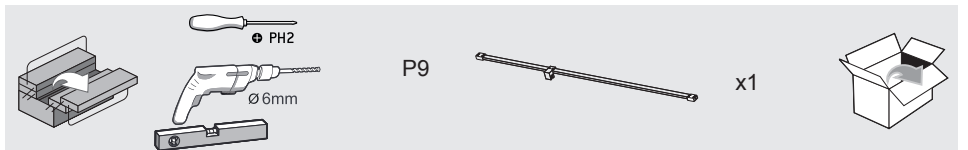
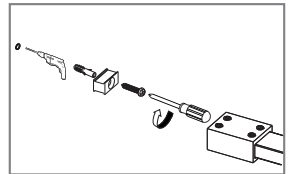
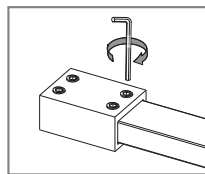
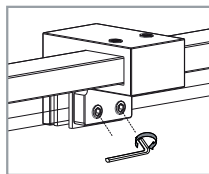
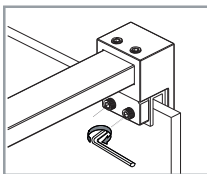
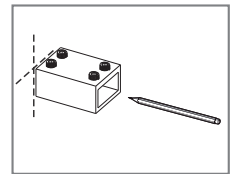
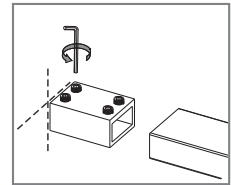
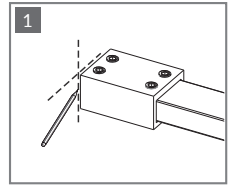
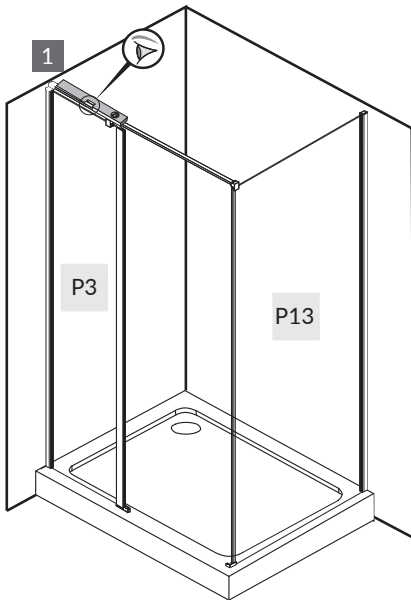
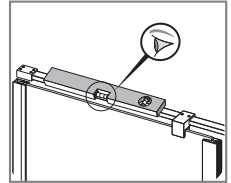
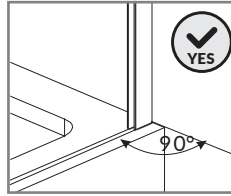
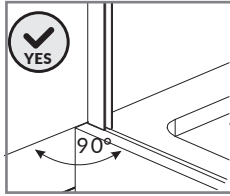
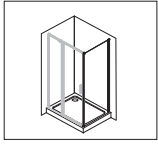

11.

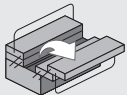
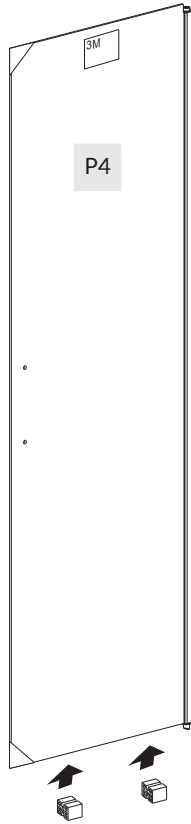
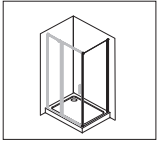

N2



x2



12.

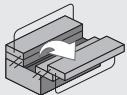
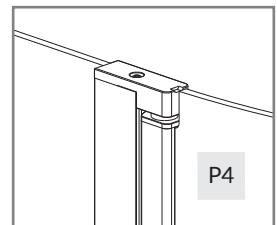
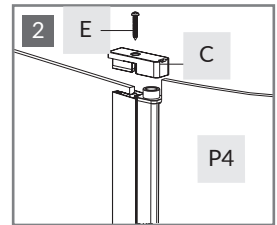
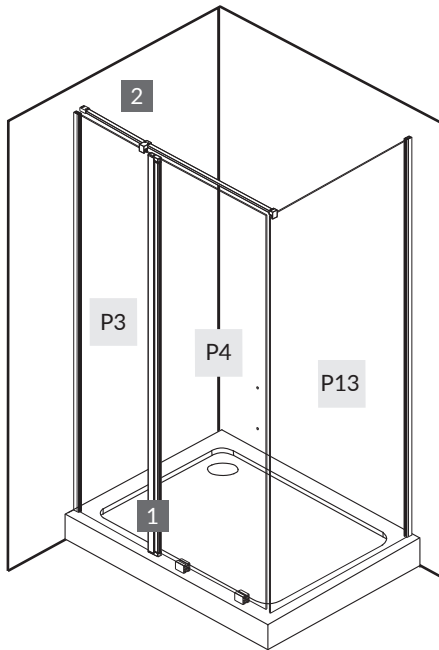
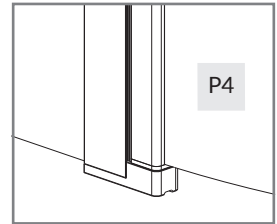
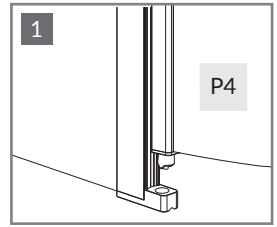
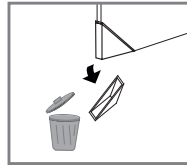
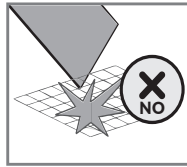
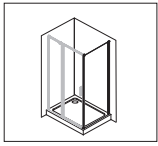

C

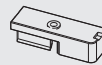

x1

E



x1



13.

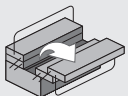
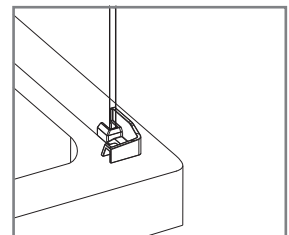
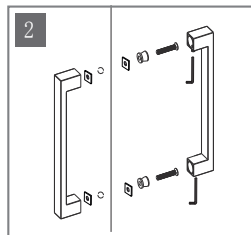
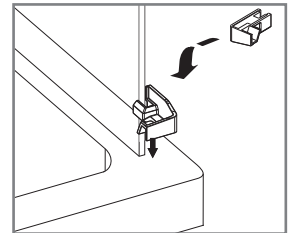
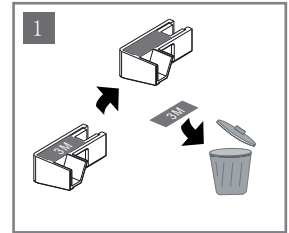
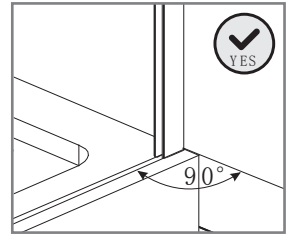
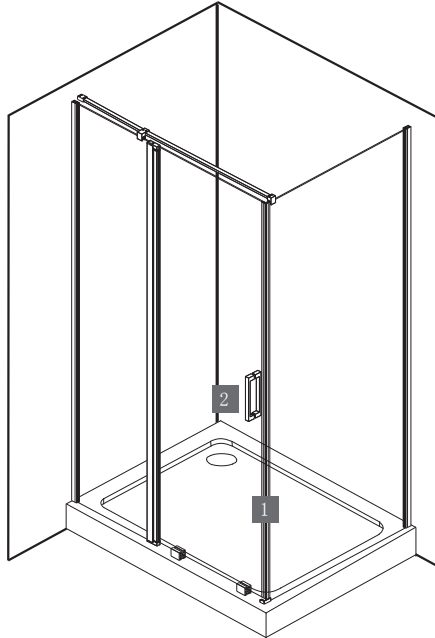
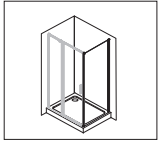

P5



x1



L1



x1



14.

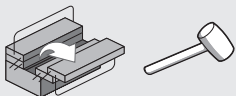
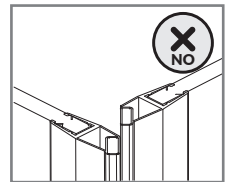
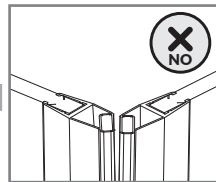
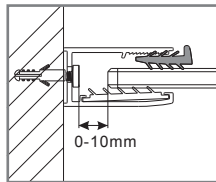
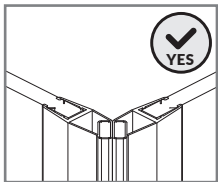
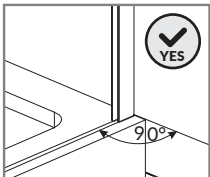
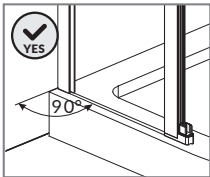
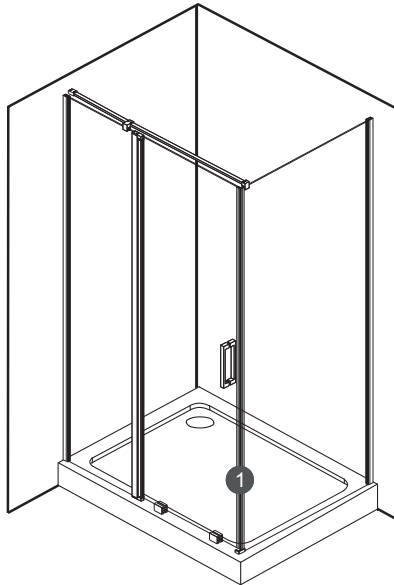
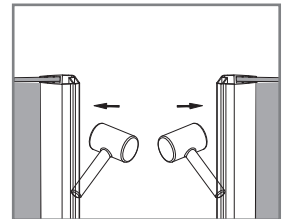
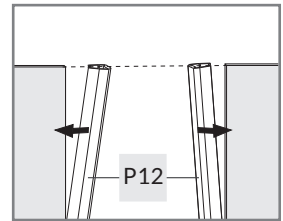
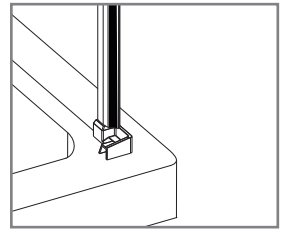
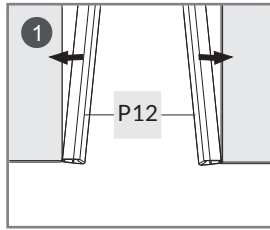
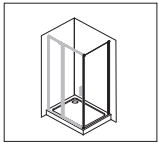

P12



x2



15.

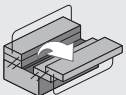
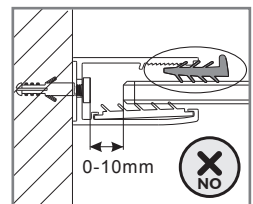
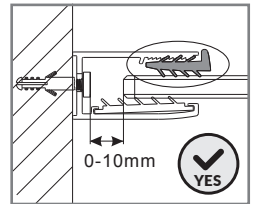
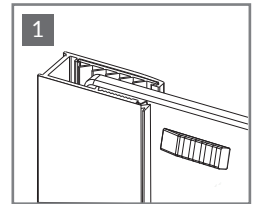
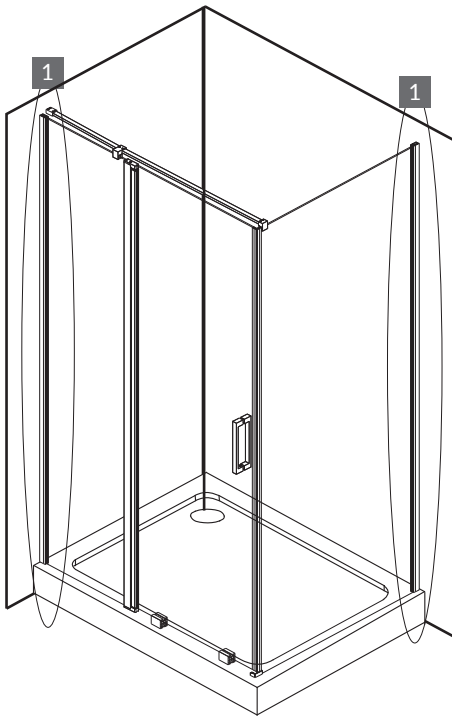
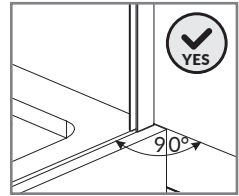
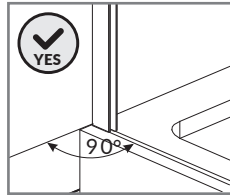
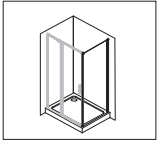

H



x1



16.

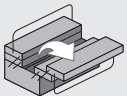
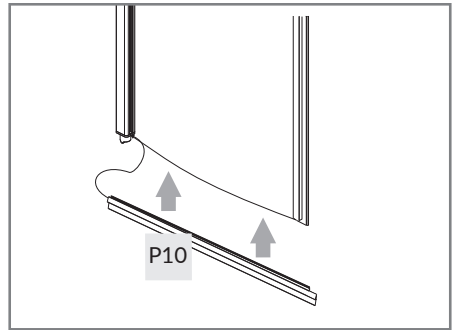
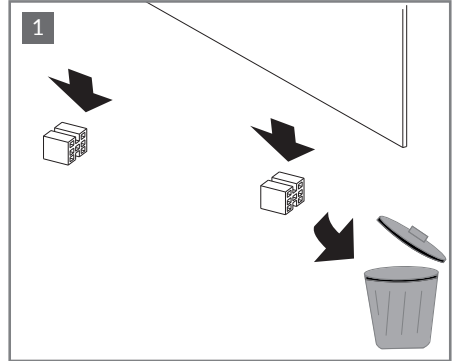
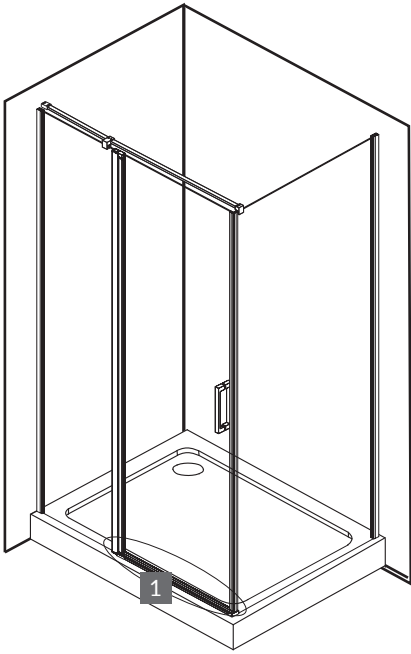
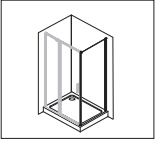

P10



x1



17.

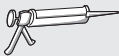
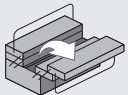
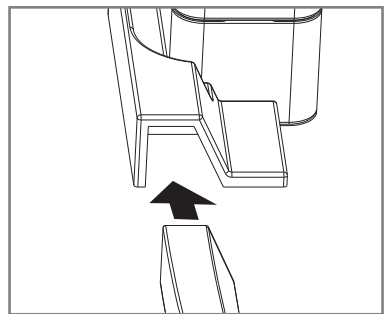
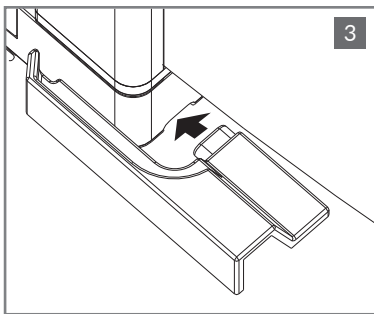
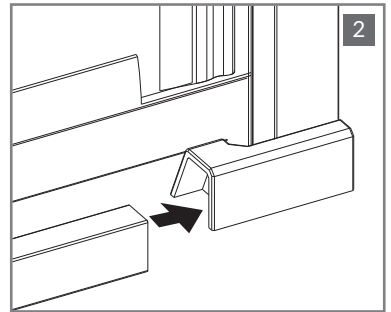
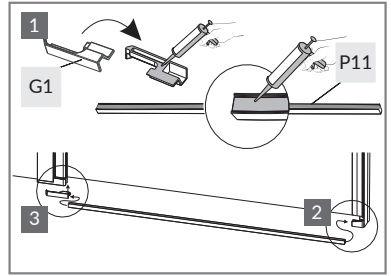
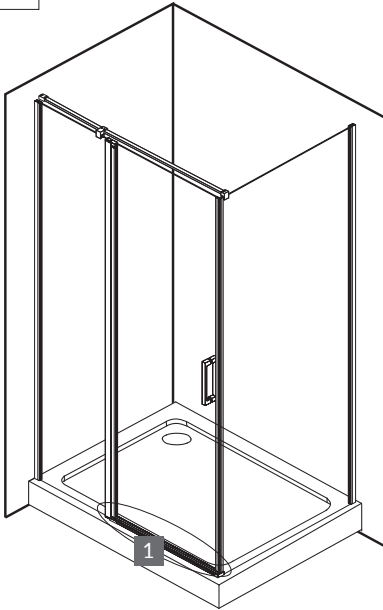
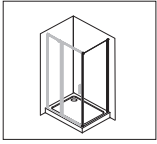

P11



x1

G1



x1



18.

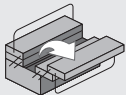
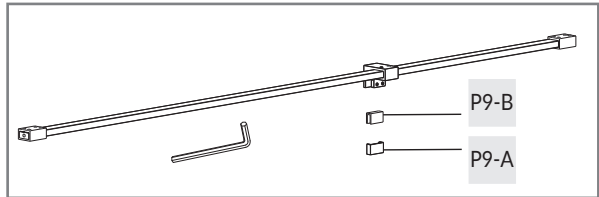
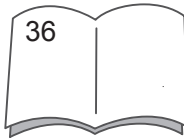
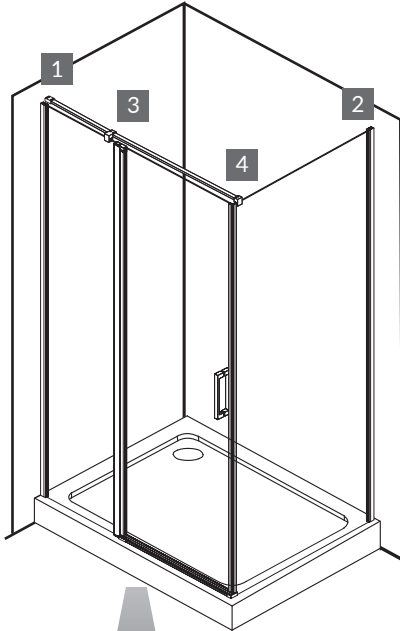
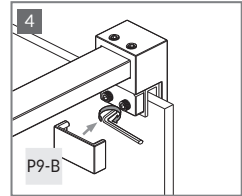
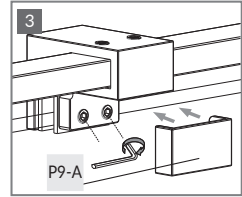
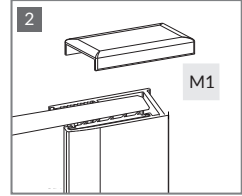
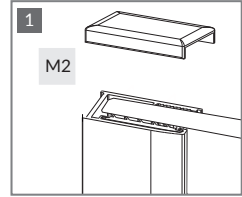
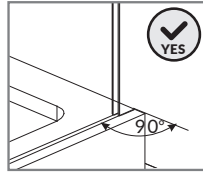
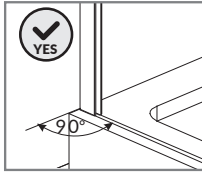
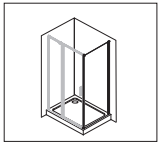

M2 x1

M1 x1



19.

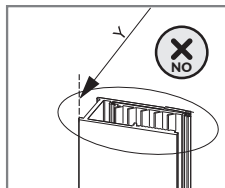
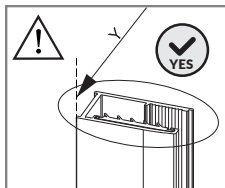
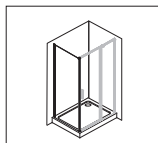

SIZE	X(mm)	Y(mm)
800x800x1950	790-800	790-800
900x800x1950	890-900	790-800
1000x800x1950	990-1000	790-800
800x900x1950	790-800	890-900
900x900x1950	890-900	890-900
1000x900x1950	990-1000	890-900

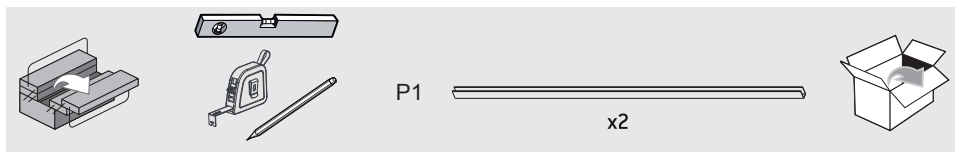
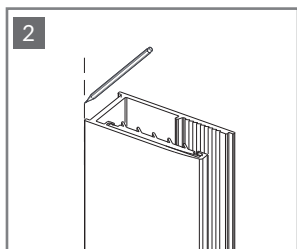
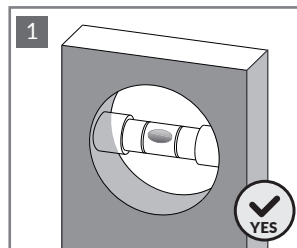
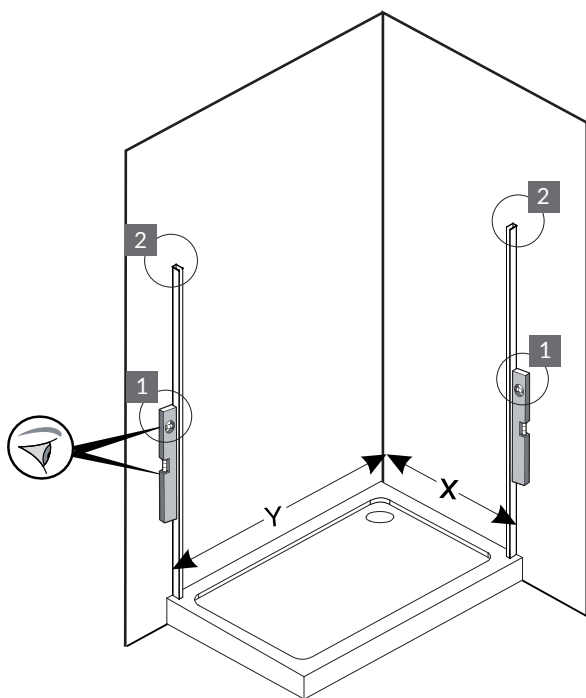

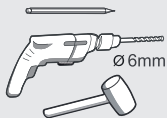
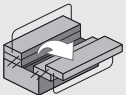
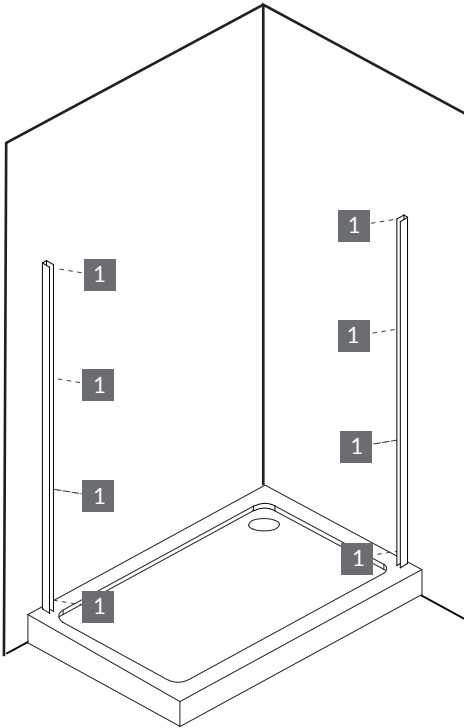
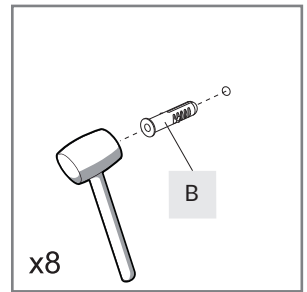
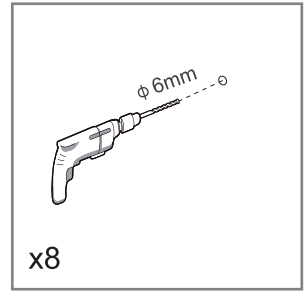
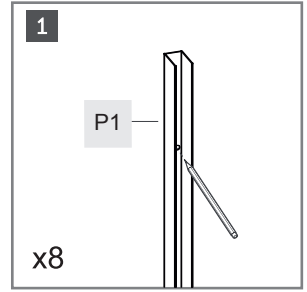
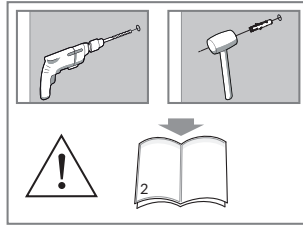
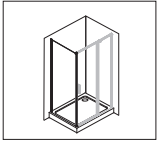

B



x8



21.

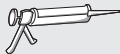
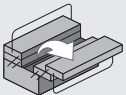
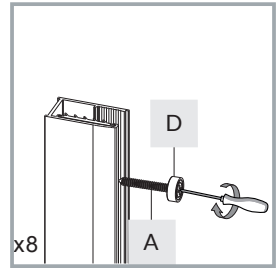
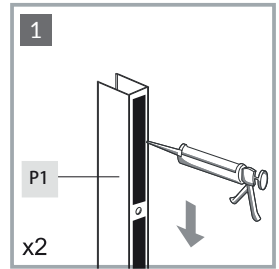
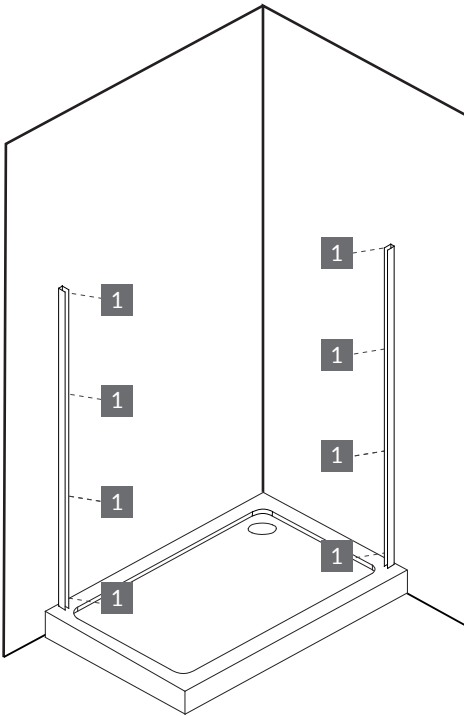
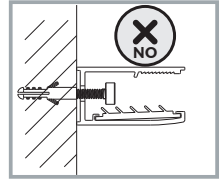
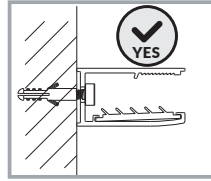
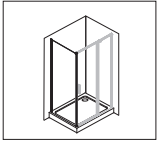

P1



x2

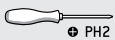

PH2

D



x8

A



x8

4X35



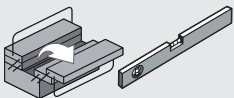
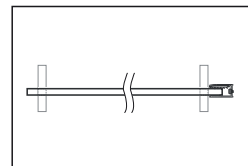
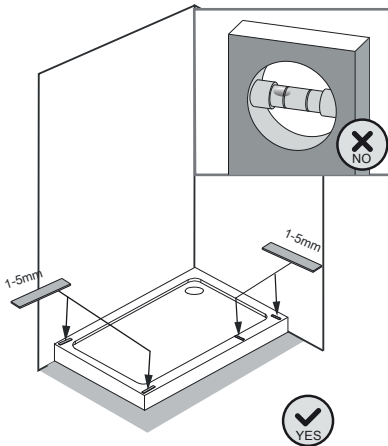
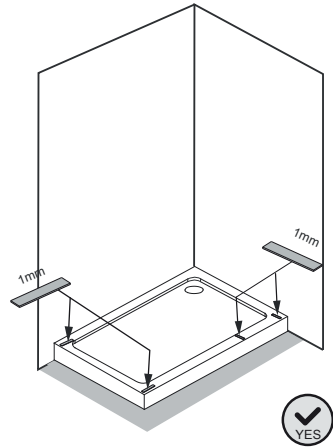
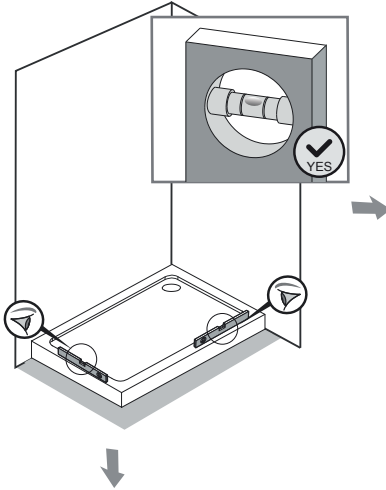
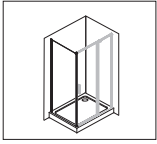

F1

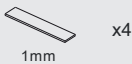

F2

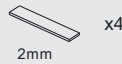

F3



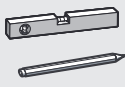
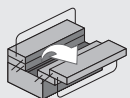
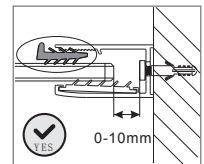
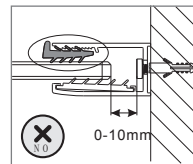
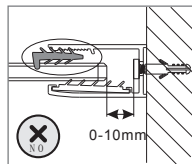
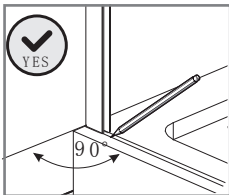
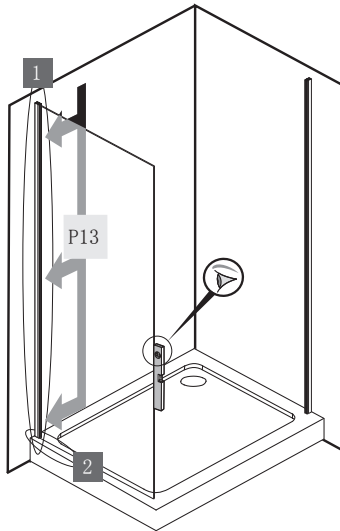
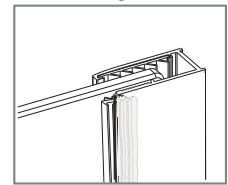
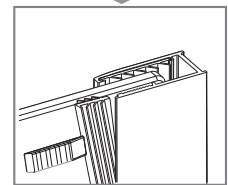
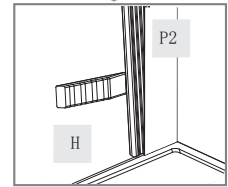
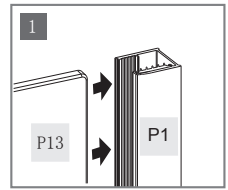
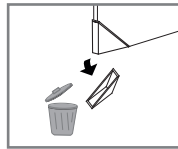
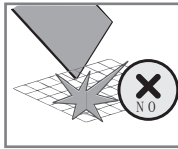
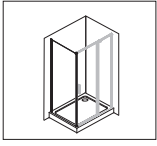

P2



x1

H



x1



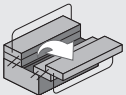
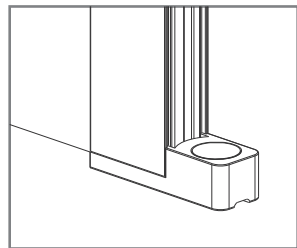
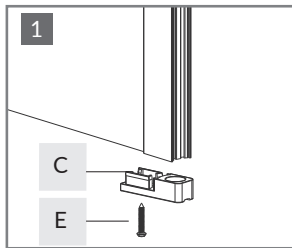
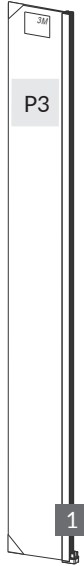
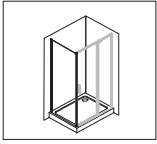

C

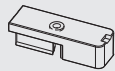

x1

E



x1



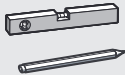
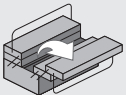
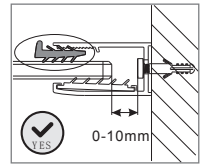
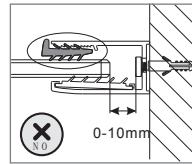
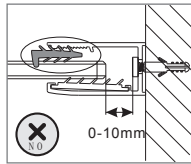
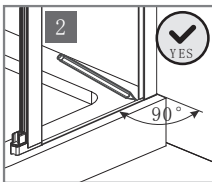
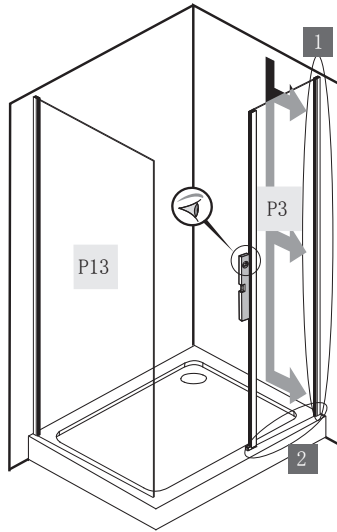
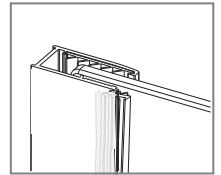
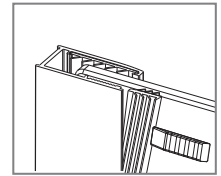
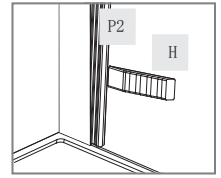
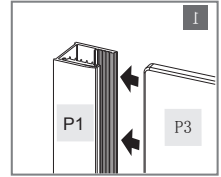
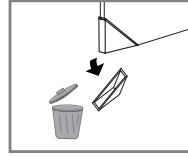
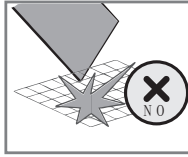
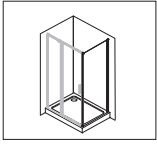

P2

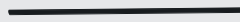

x1

H



x1



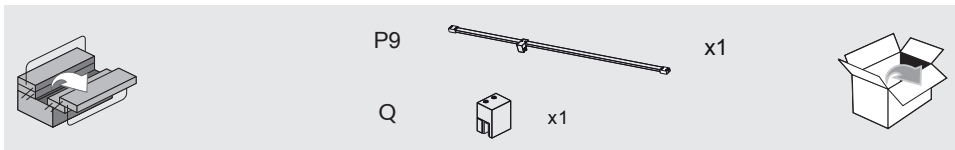
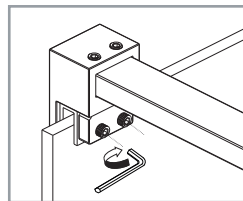
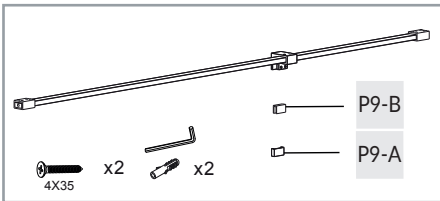
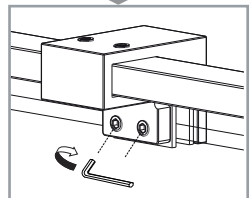
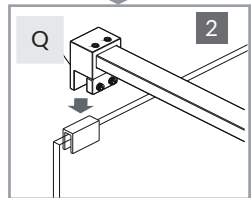
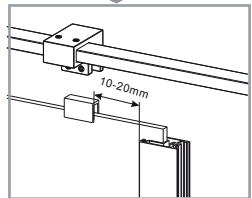
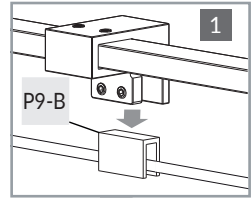
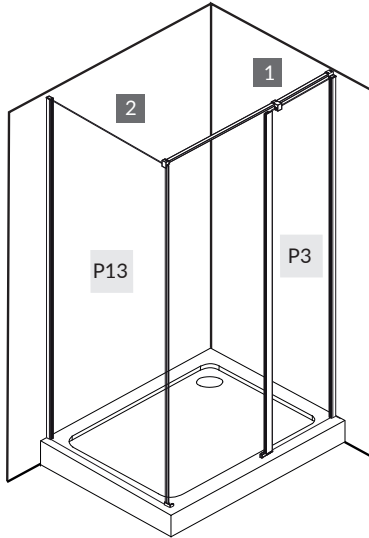
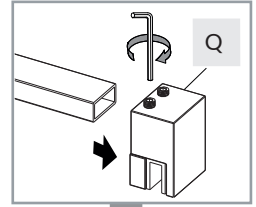
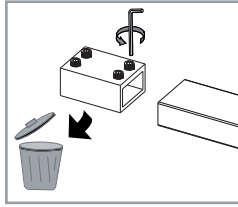
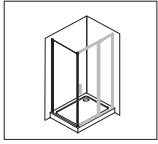

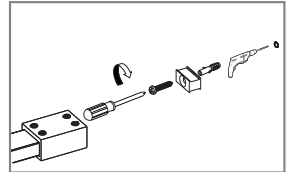
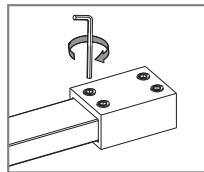
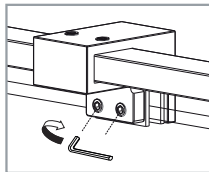
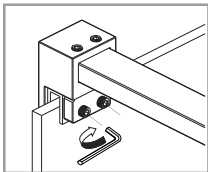
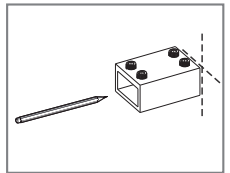
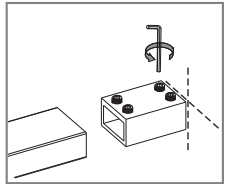
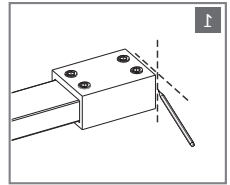
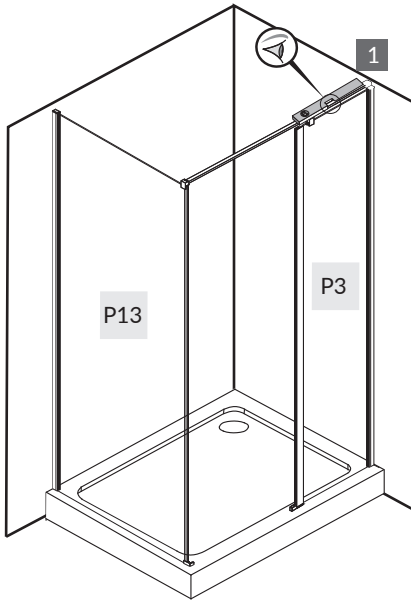
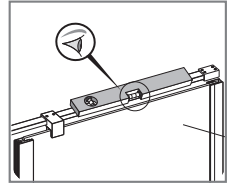
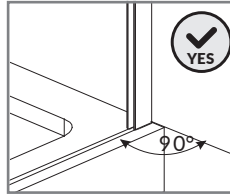
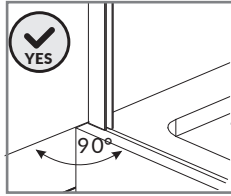
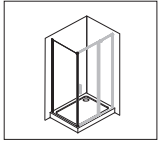

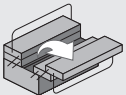
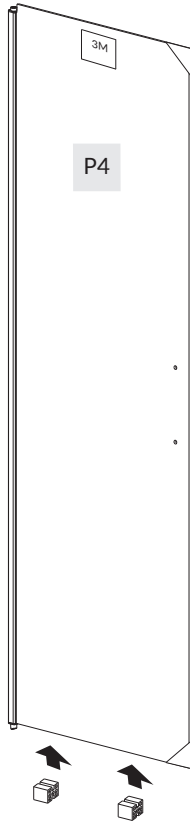
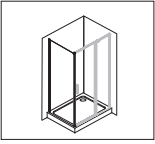

N2



x2



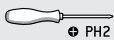
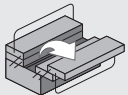
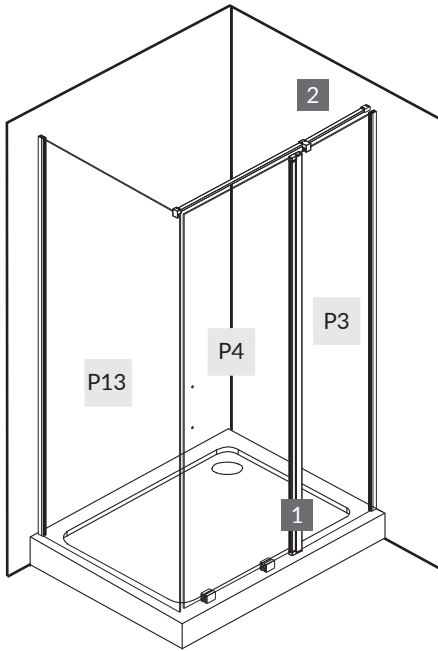
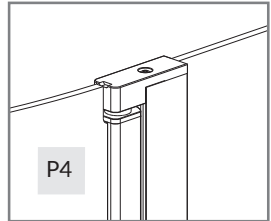
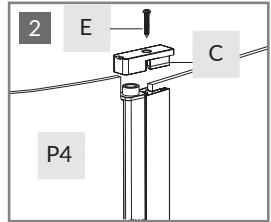
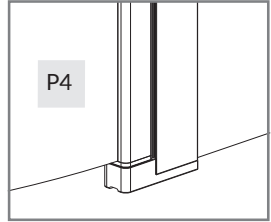
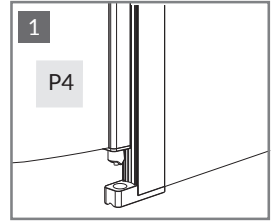
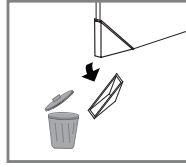
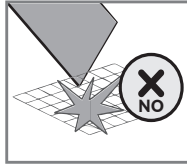
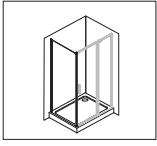

C

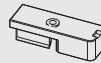

x1

E



x1



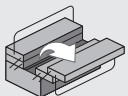
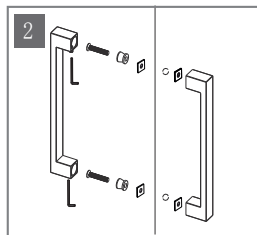
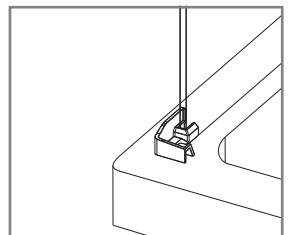
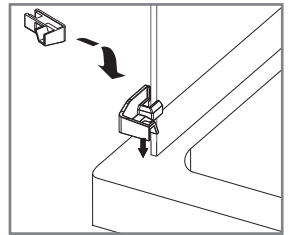
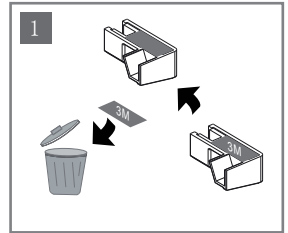
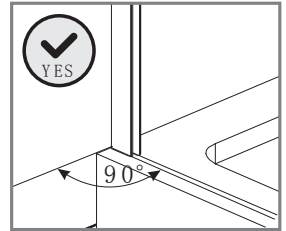
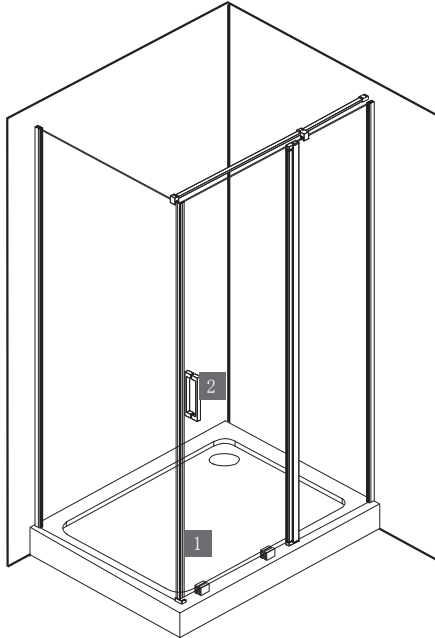
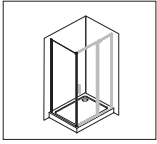

P5



x1



L2



x1



31.

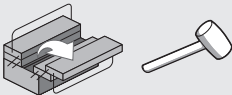
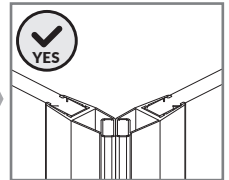
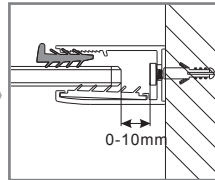
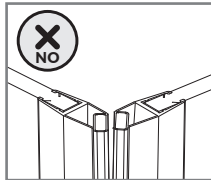
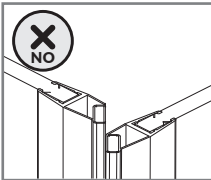
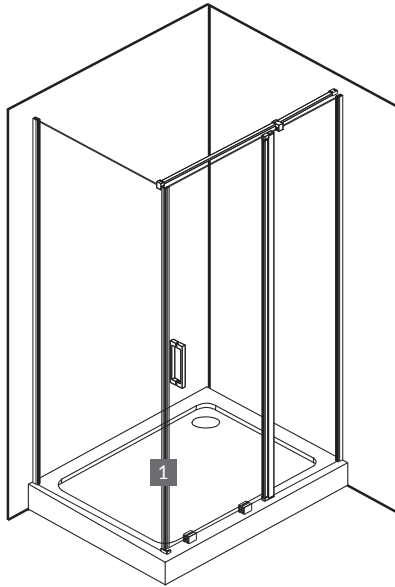
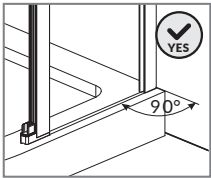
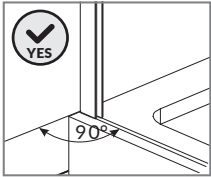
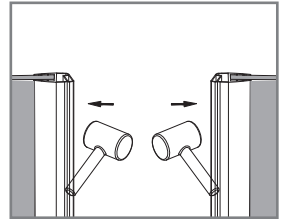
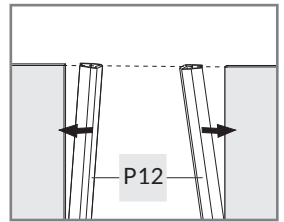
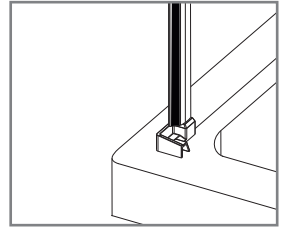
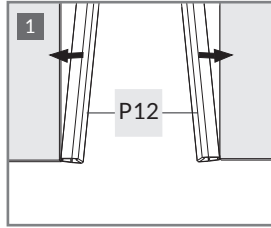
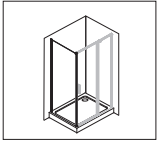

P12



x2



32.

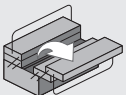
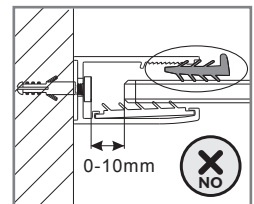
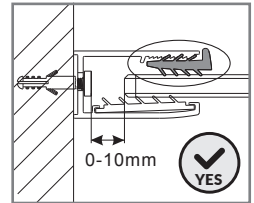
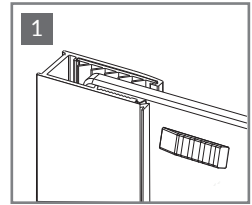
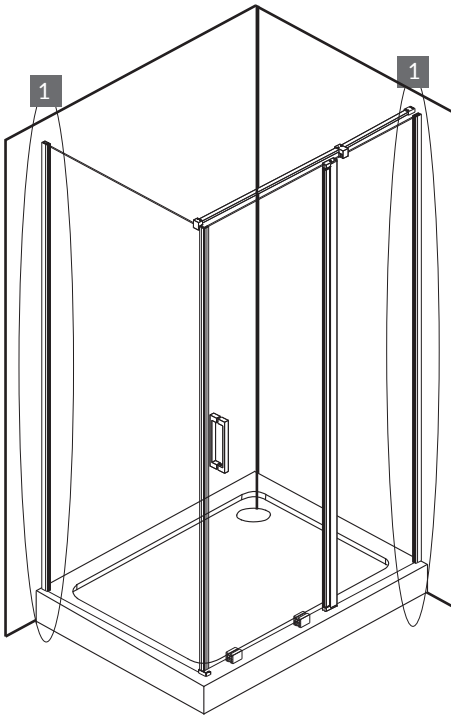
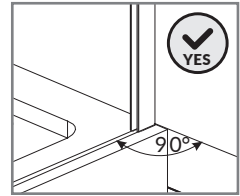
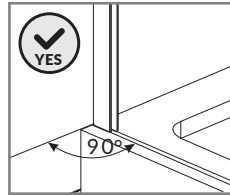
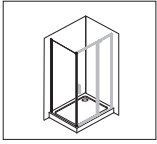

H



x1



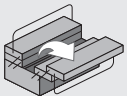
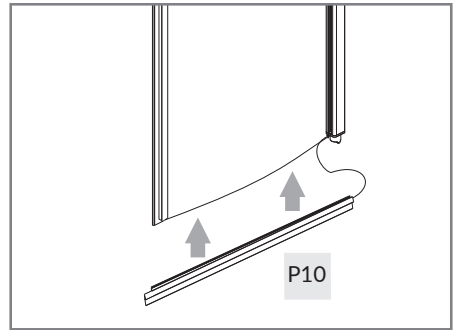
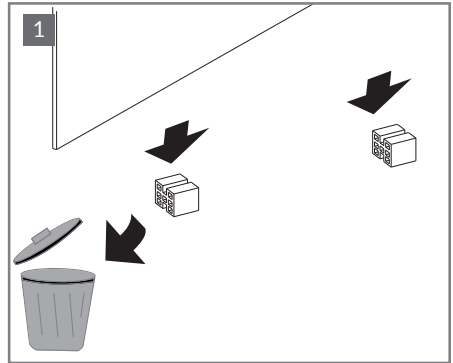
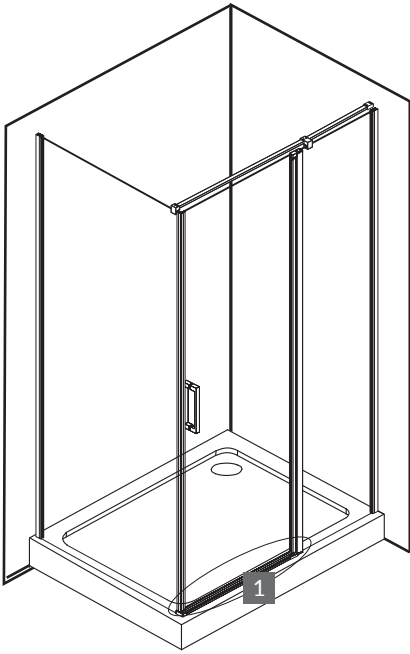
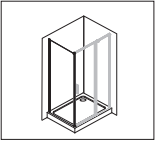

P10



x1



34.

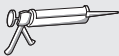
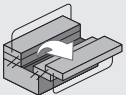
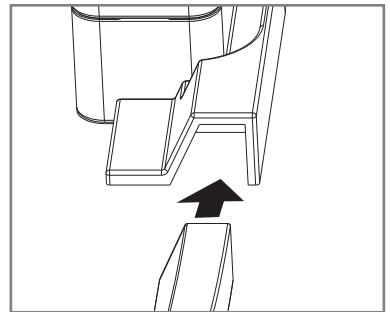
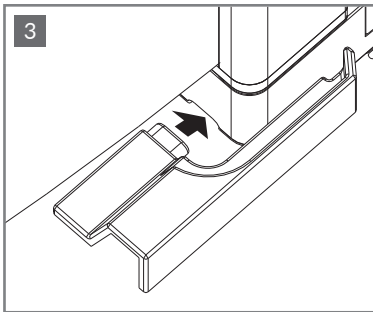
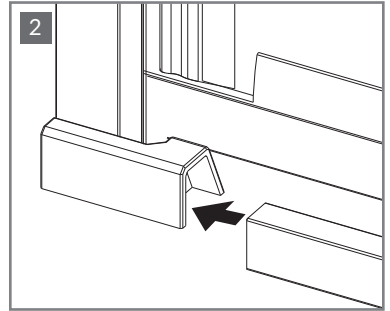
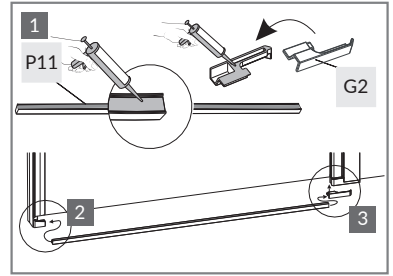
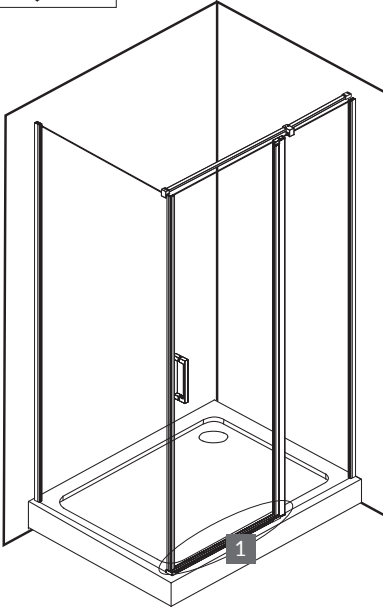
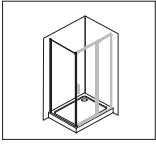

P11



x1

G2



x1



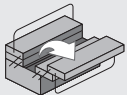
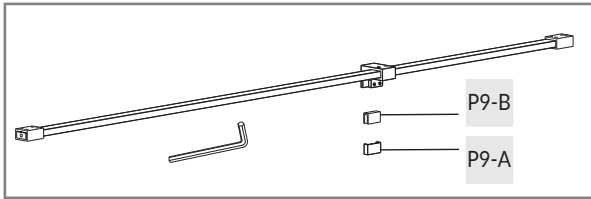
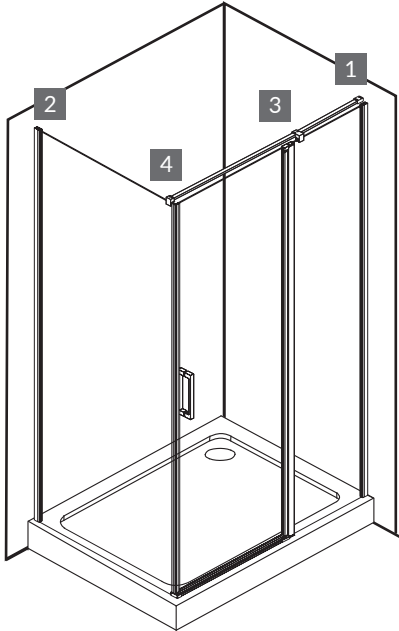
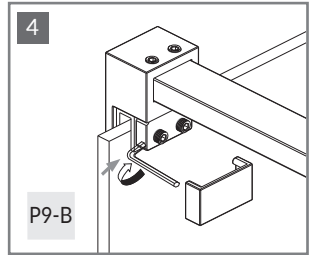
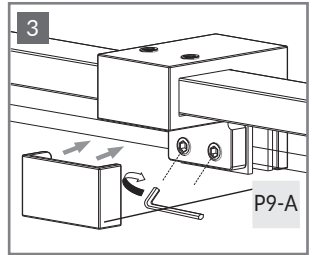
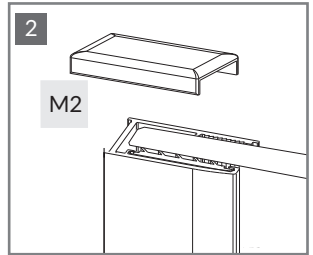
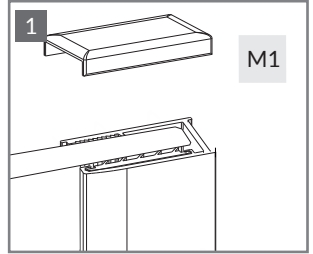
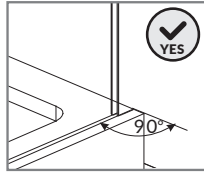
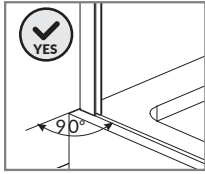
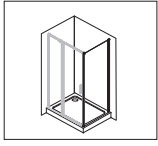

M2  x1

M1  x1



36.

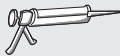
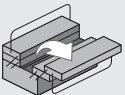
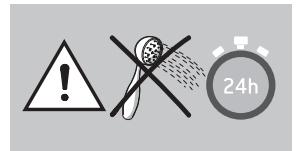
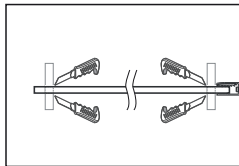
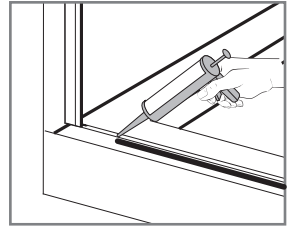
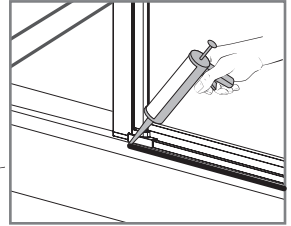
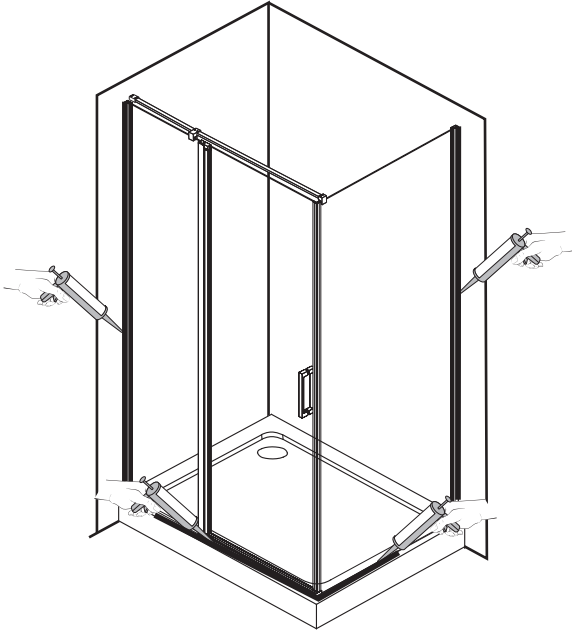
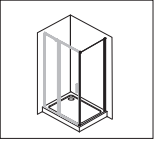



6.5<PH<7.5

