

# BASIC

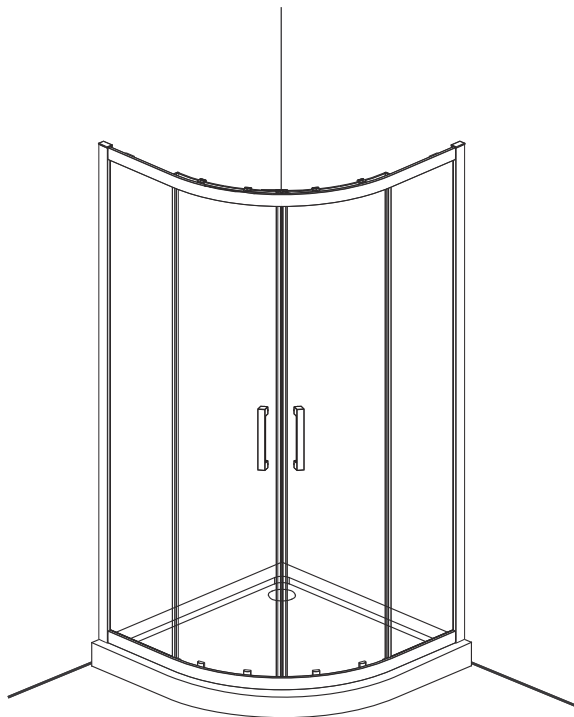

PL INSTRUKCJA MONTAŻU I EKSPLOATACJI

CZ NÁVOD NA MONTÁŽ A ÚDRŽBU

SK NÁVOD NA MONTÁŽ A ÚDRŽBU

EST PAIGALDUS- JA KASUTUSJUHEND

LT MONTAVIMO IR EKSPLOATAVIMO INSTRUKCIJA

LV MONTĀŽAS UN EKSPLUATĀCIJAS INSTRUKCIJA

DE MONTAGE- UND AUFBAUANLEITUNG

RO INSTRUCȚIUNI DE MONTAJ ȘI OPERARE

HU SZERELÉSI ÉS ÜZEMELTETÉSI ÚTMUTATÓ

UA ІНСТРУКЦІЯ З МОНТАЖУ І ЕКСПЛУАТАЦІЇ

BY ІНСТРУКЦЫЯ ПА МАНТАЖЫ І ЭКСПЛУАТАЦЫІ

RU ИНСТРУКЦИЯ ПО МОНТАЖУ И ЭКСПЛУАТАЦИИ

EN INSTRUCTIONS FOR ASSEMBLY AND USE

FR INSTALLATION ET UTILISATION - MODE

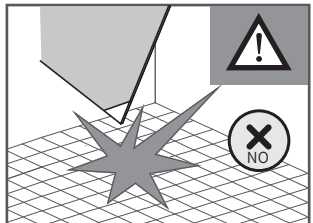
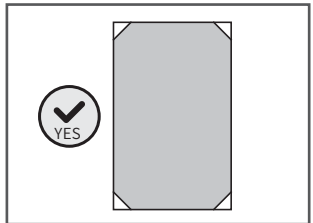
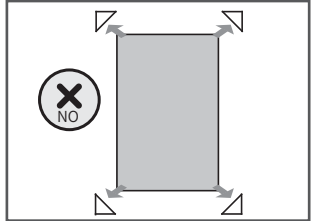
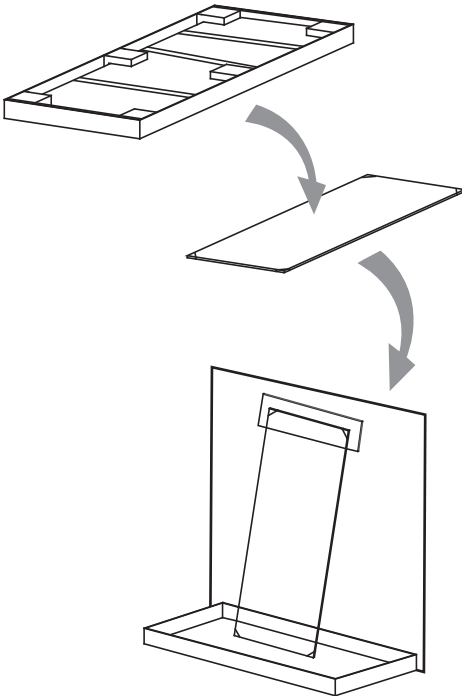
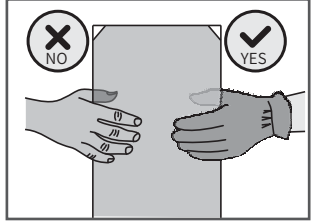
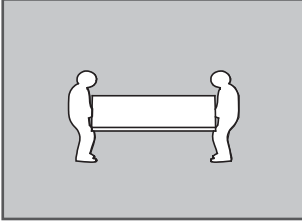
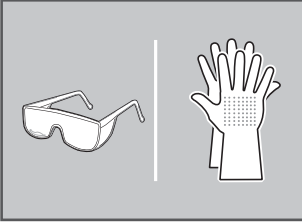
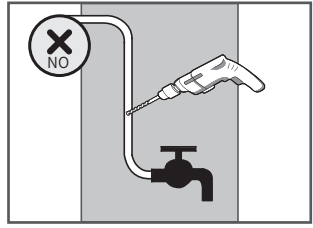
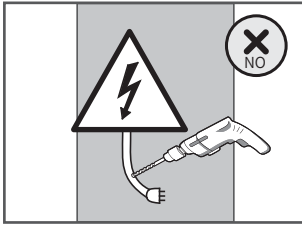
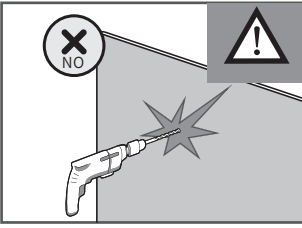

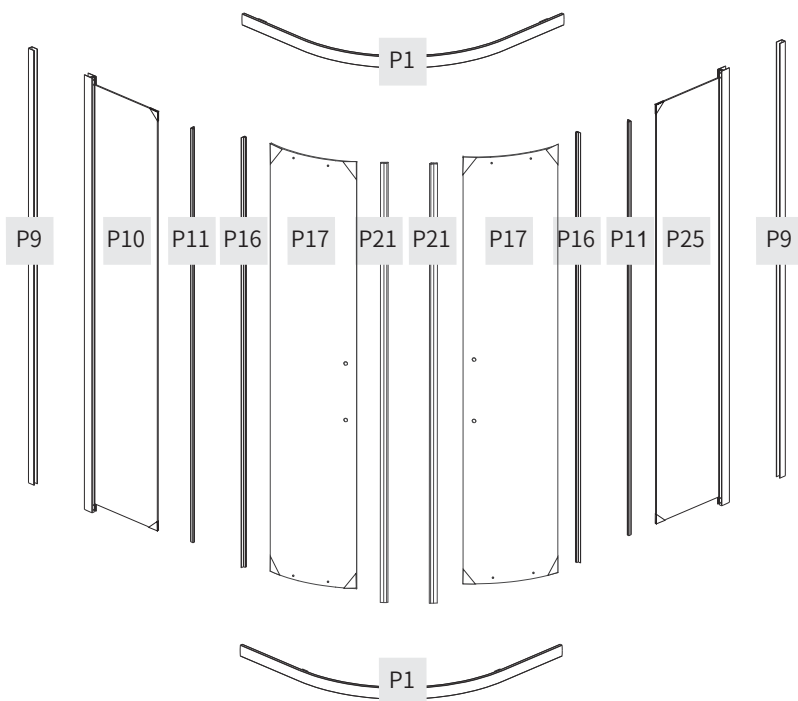



H1



x8

H2



ST4x30 mm

x8

H3



ST4x9.5 mm

x10

H4



x1

H5



x1

H6



x2

H7



x4

H8



x2

H9



x1

H10



x1

H11



x4

H12



x4

H13



x2

H14



x6

H15



x6

H17



ST3.5x30 mm

x8

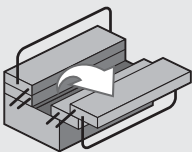

PH2

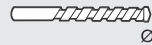
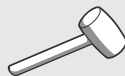

Ø6mm



Ø3mm

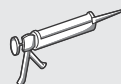
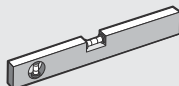

1.

SIZE(mm)	X(mm)	Y (mm)
800x800	783~798	783~798
900x900	883~898	883~898

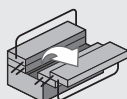
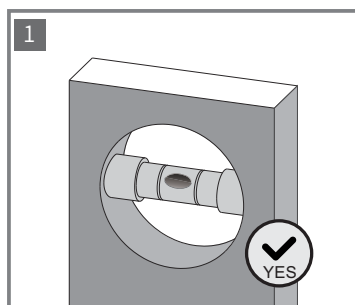
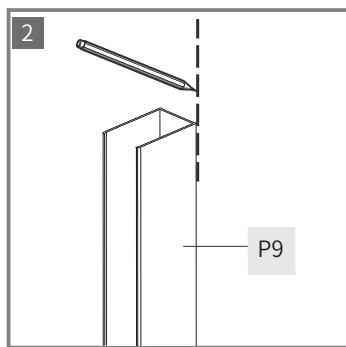
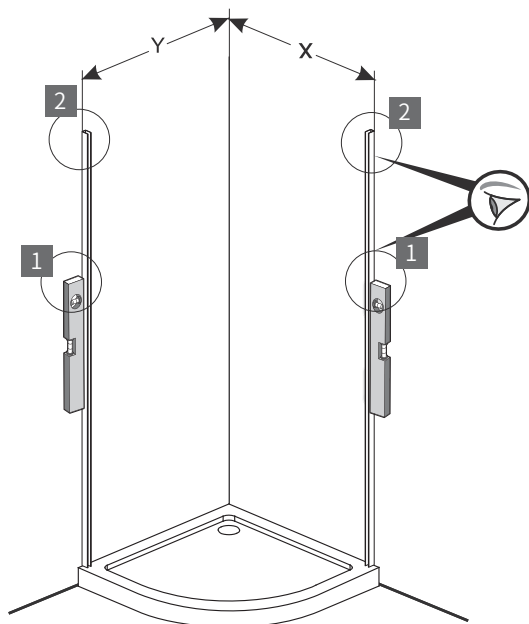

P9

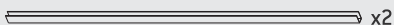

2.

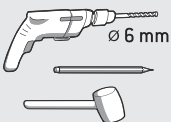
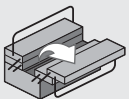
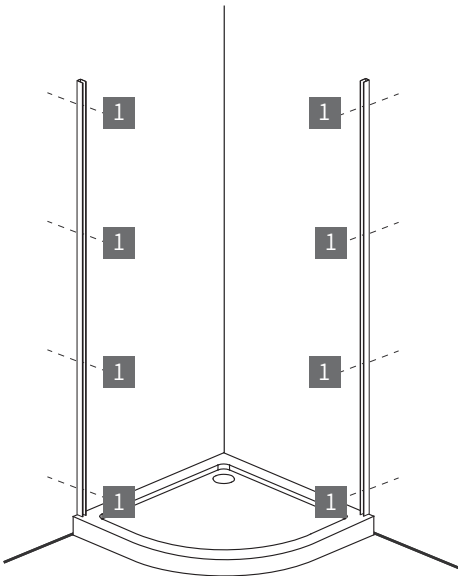
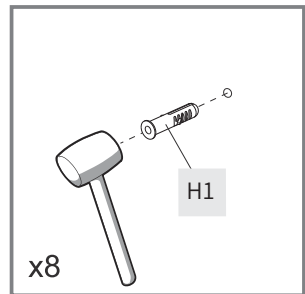
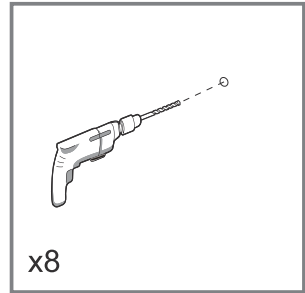
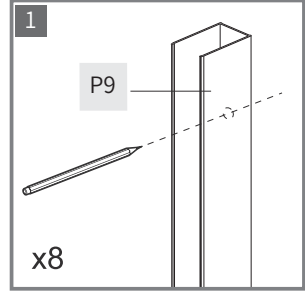
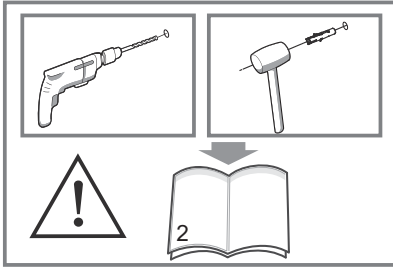

P9  x2

H1  x8



3.

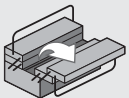
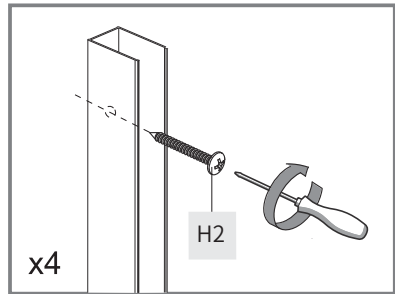
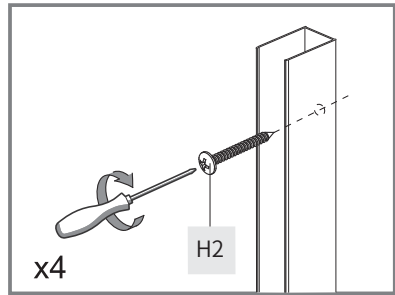
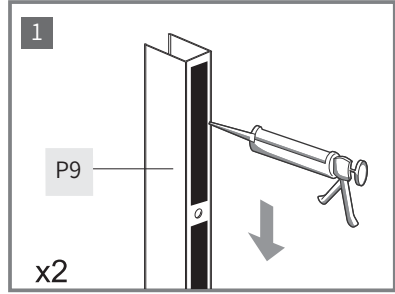
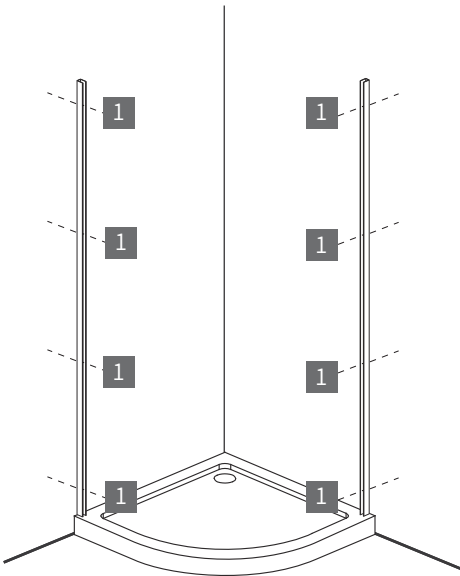

P9 x2

H2 x8



4.

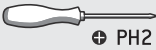
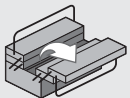
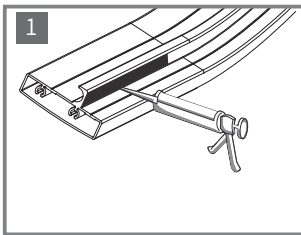
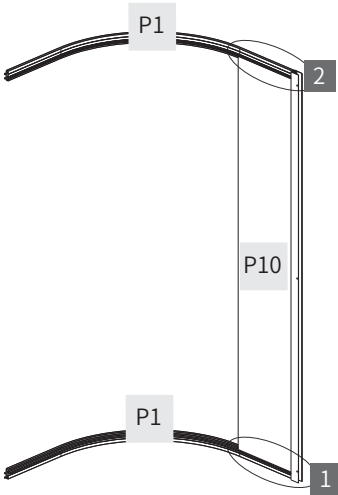
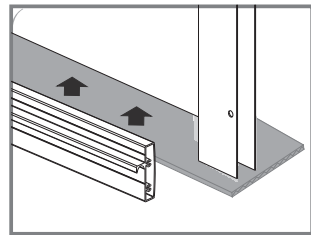
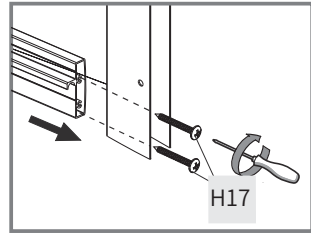
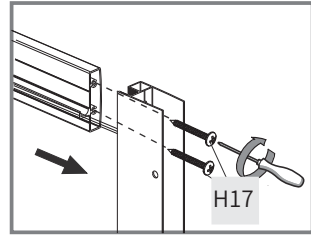
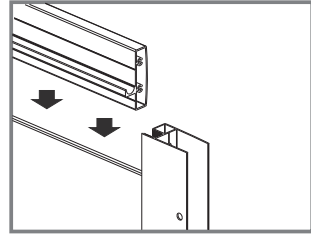
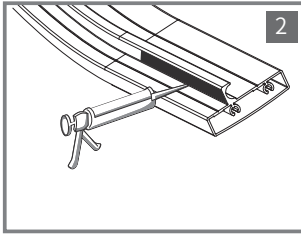

H17



x4





5.

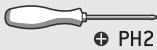
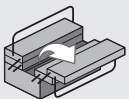
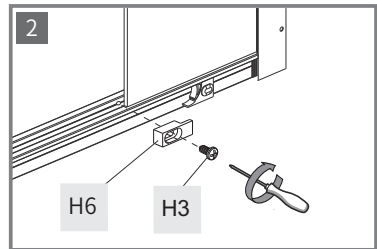
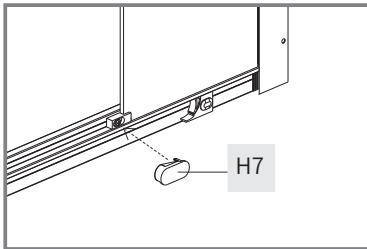
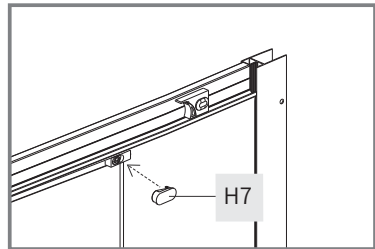
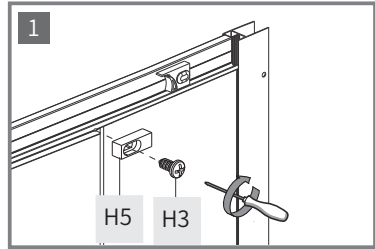
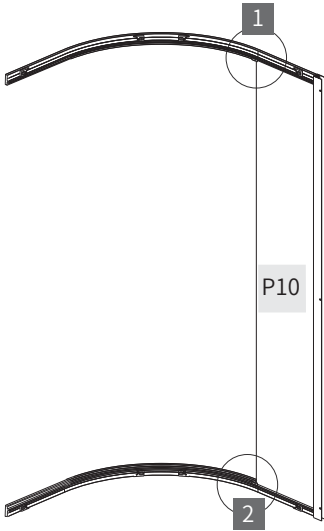

H3  x2

H6  x1

H5  x1

H7  x2



6.

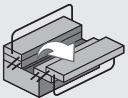
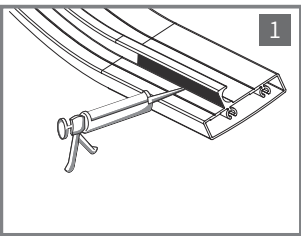
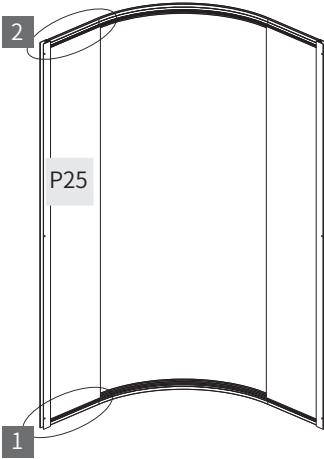
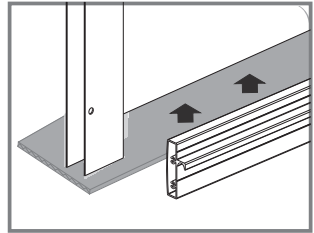
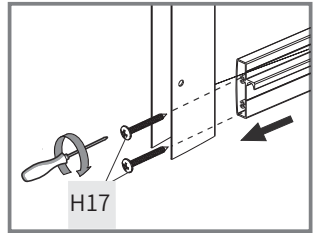
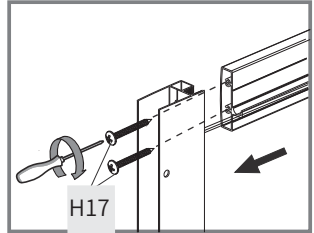
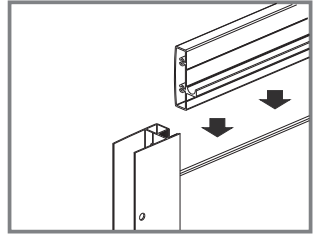
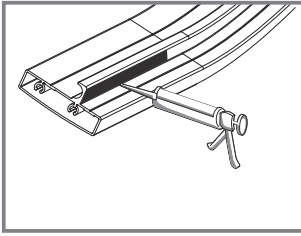

H17

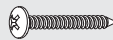

x4



7.

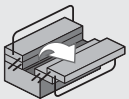
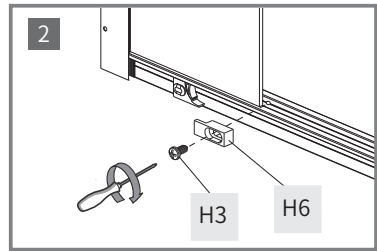
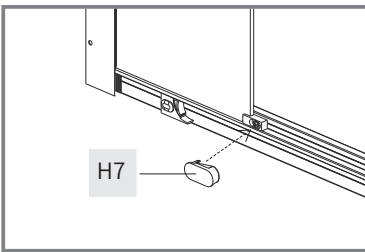
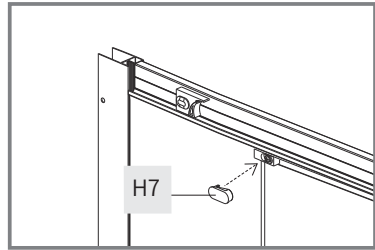
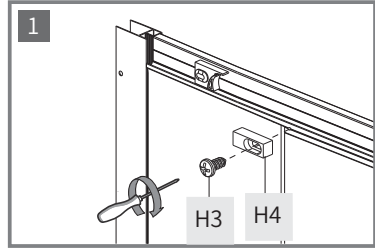
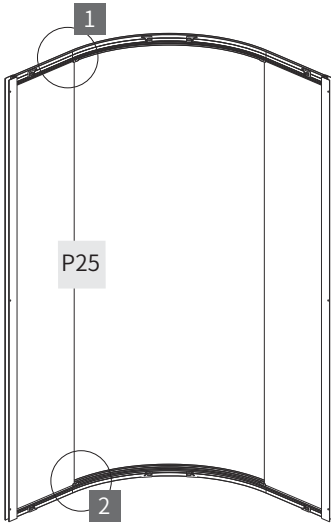

H3  x2

H6  x1

H4  x1

H7  x2



8.

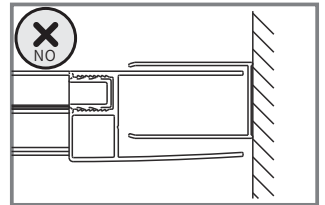
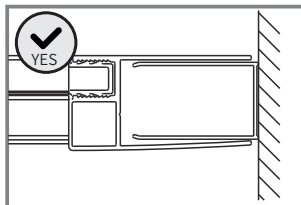
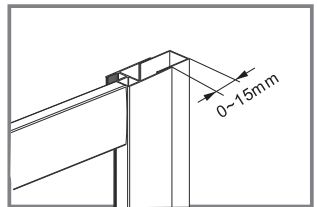
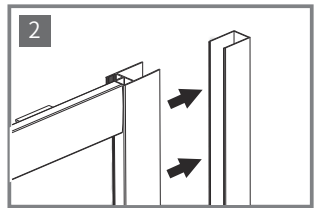
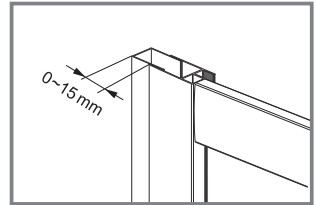
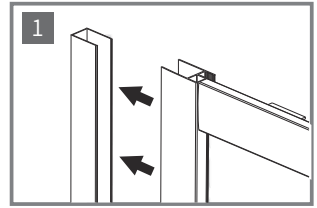
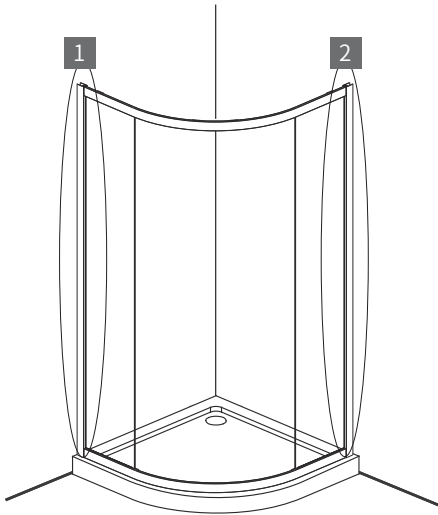

9.

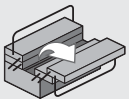
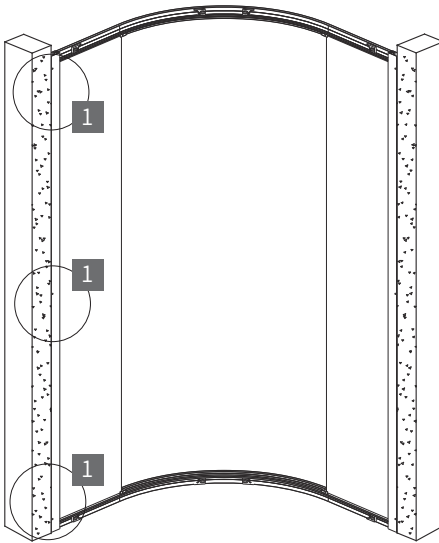
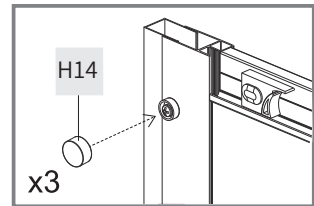
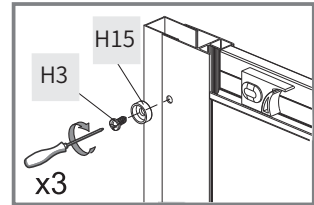
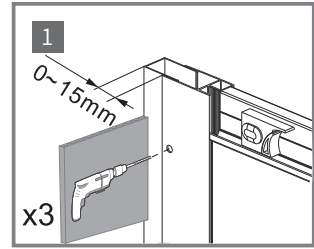
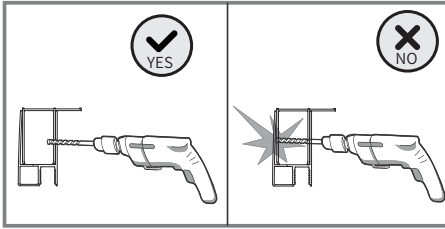

H3  x3

H14  x3

H15  x3



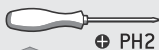
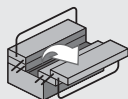
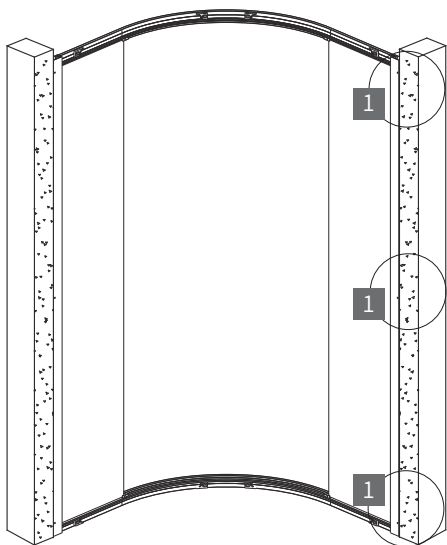
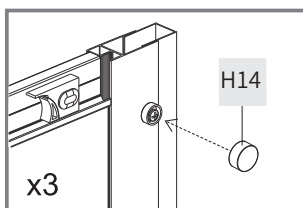
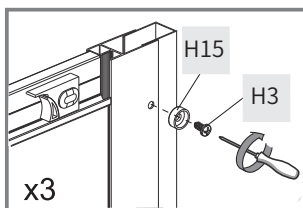
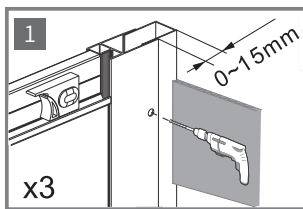
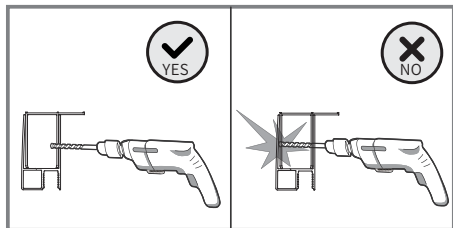

11.

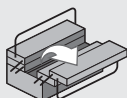
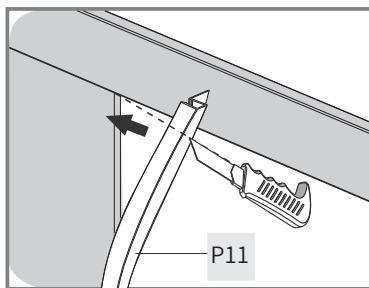
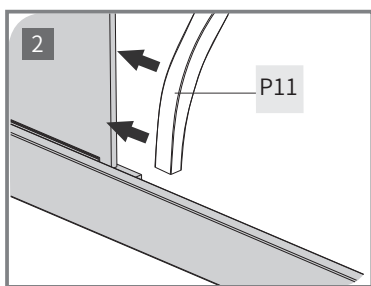
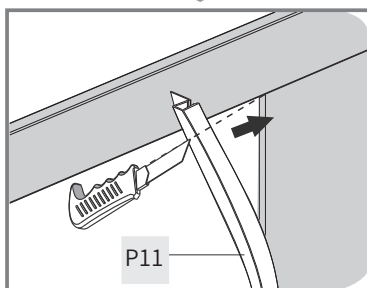
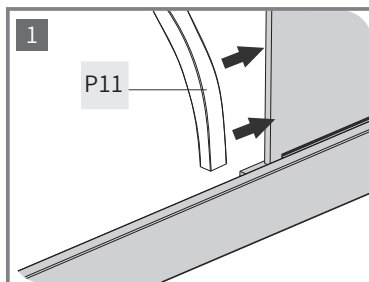
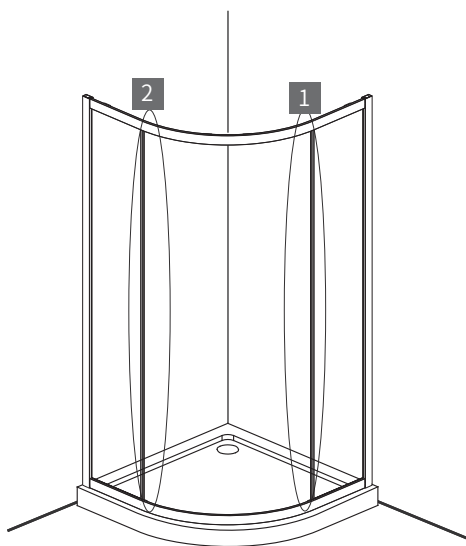

P11



x2



12.

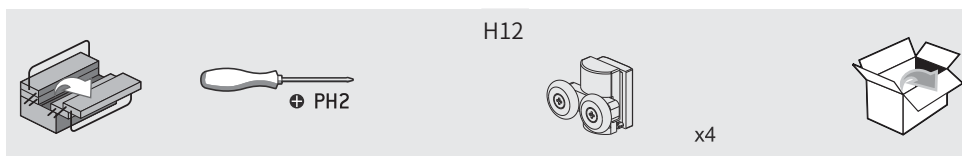
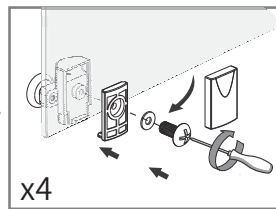
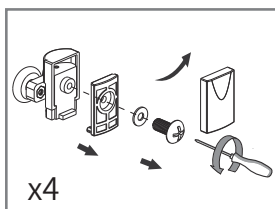
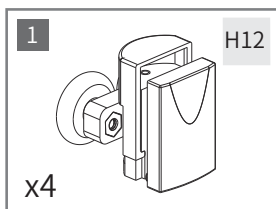
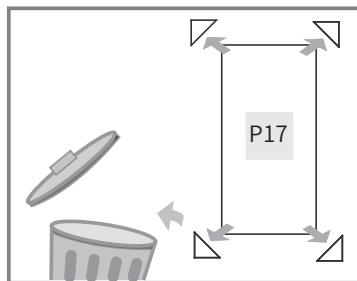
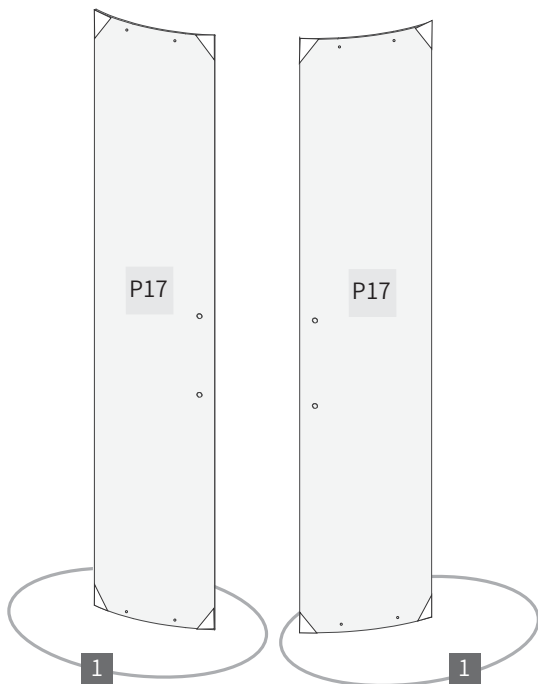



13.

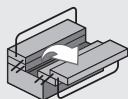
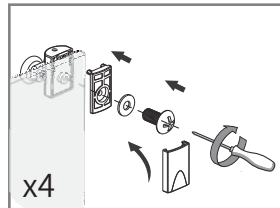
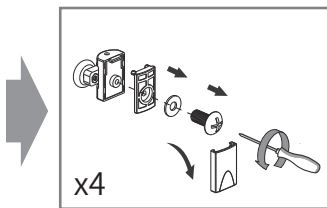
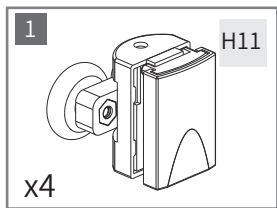
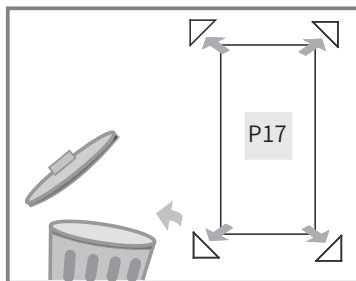
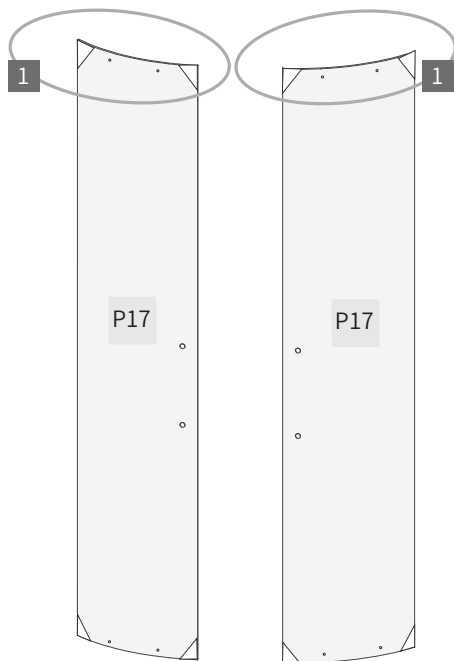

H11



x4



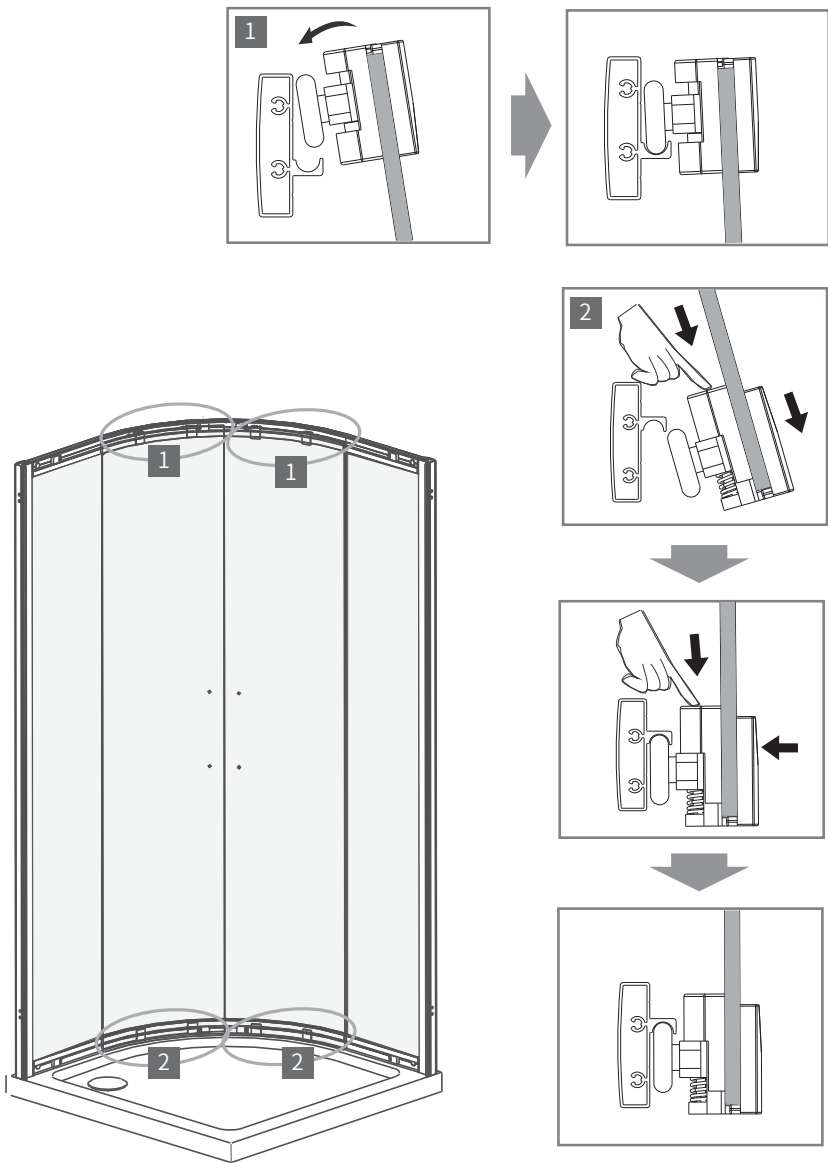

15.

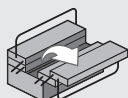
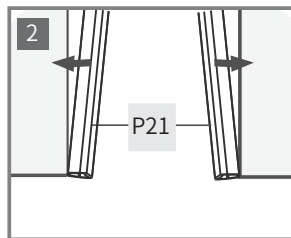
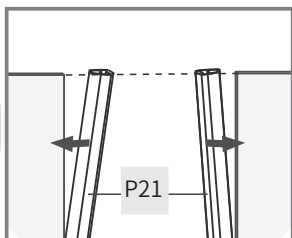
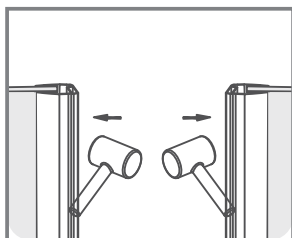
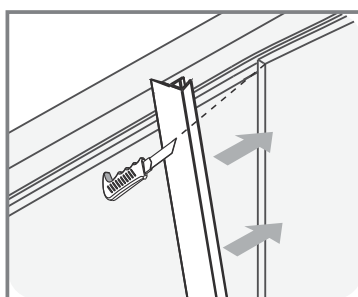
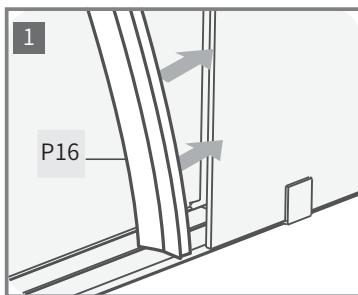
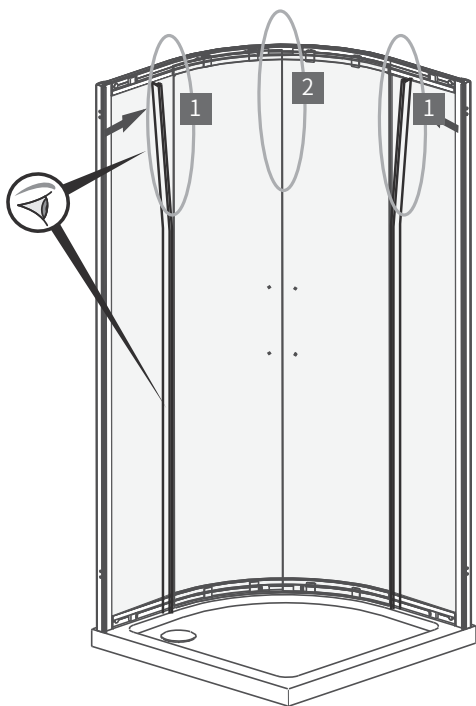

P16  x2

P21  x2



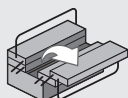
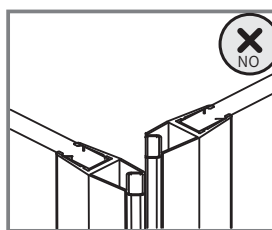
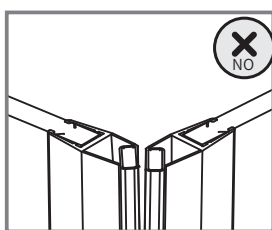
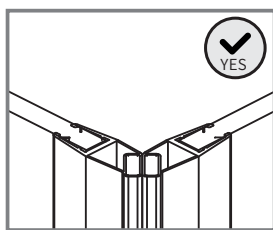
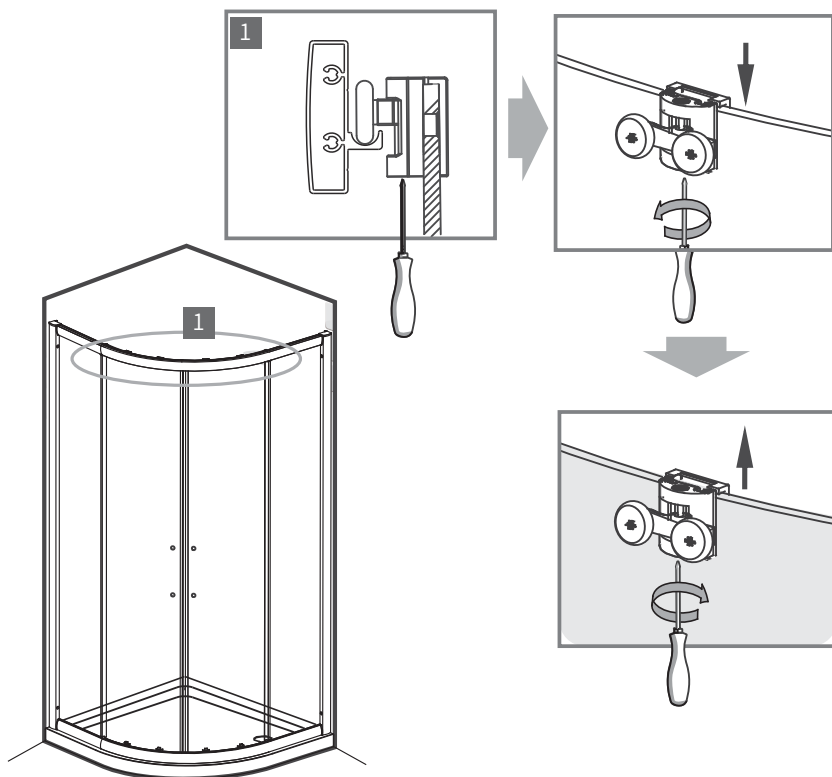

➕ PH2



17.

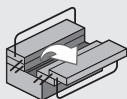
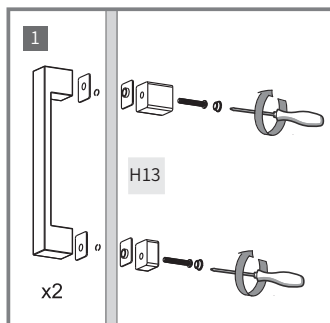
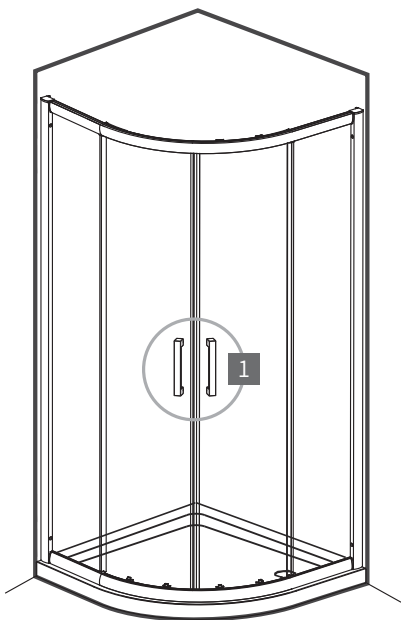

H13

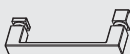

x2



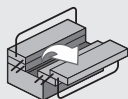
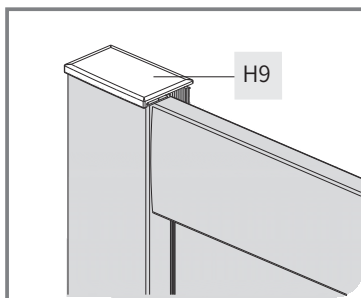
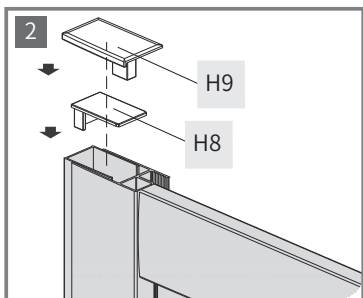
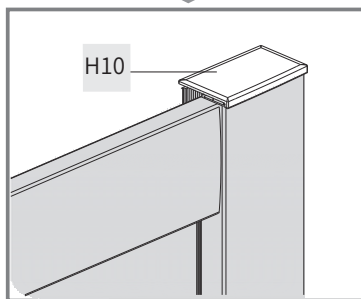
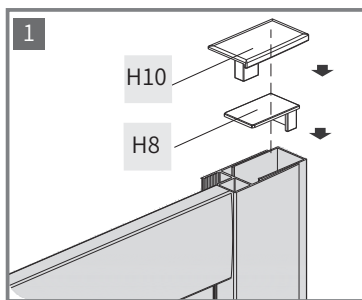
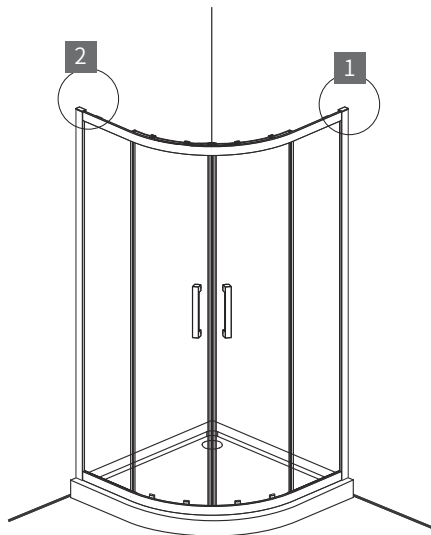

H8



x2

H9



x1

H10



x1



19.

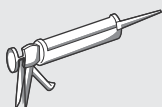
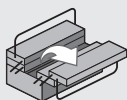
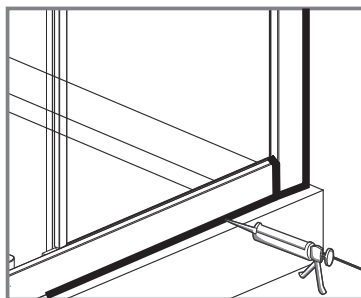
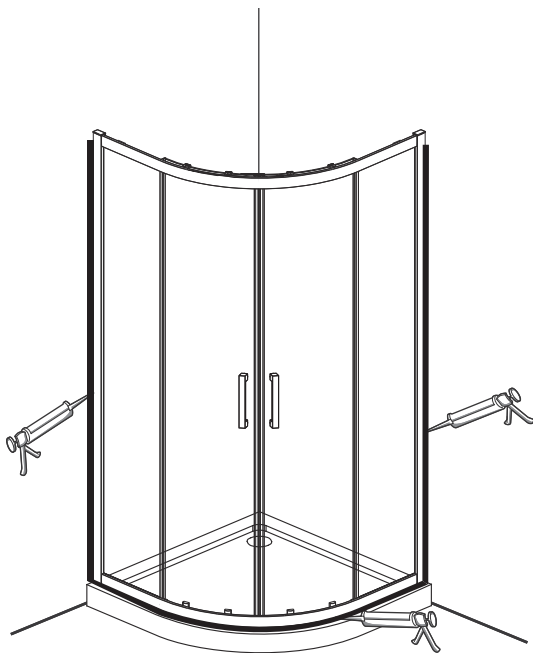



6.5 < PH < 7.5

